



**TABLE OF CONTENTS**

Executive Order ..... 5

Foreword..... 16

Signatories to the Louisiana Emergency Operations Plan..... 17

Record of Changes..... 21

Record of Distribution and Review..... 22

Basic Plan ..... 24

I. Purpose and Scope..... 26

II. Situation and Assumptions..... 26

III. Concept of Operations ..... 28

IV. Organization and Assignment of Responsibilities ..... 30

V. Direction and Control ..... 36

VI. Continuity of Government/Continuity of Operations..... 37

VII. Administration and Logistics ..... 38

VIII. Plan Development and Maintenance ..... 39

IX. Authorities and References ..... 40

X. Glossary/Definitions of Terms ..... 42

XI. Attachments to Basic Plan ..... 44

Attachment 1-State Organizational Chart ..... 2-1

Attachment 2-Hazards and Vulnerabilities ..... 2-2

Attachment 3A-Emergency Support Functions and Responsibility Chart ..... 3-1

Attachment 3B-Recovery Support Functions and Responsibility Chart ..... 3-3

Attachment 4-Tribal Affairs..... 4-69

Attachment 5: Resource Request Flow Chart..... 5-72

Attachment 5A: Parish Level Resource Request Flow Chart..... 5-2

Attachment 5B: State Level Resource Request Flow Chart ..... 5-3

Attachment 5C: Unified Command Structure Chart ..... 5-4

Attachment 5D: Unified Command Group Chart.....	5-5
Emergency Support Function 1-Transportation Annex .....	ESF 1-1
Emergency Support Function 2-Communications Annex .....	ESF 2-1
Emergency Support Function 3-Public Works and Engineering Annex.....	ESF 3-1
Emergency Support Function 4-Firefighting Annex .....	ESF 4-1
Emergency Support Function 5-Emergency Management Annex.....	ESF 5-1
Emergency Support Function 6-Mass Care, Housing, and Human Services Annex .....	ESF 6-1
Emergency Support Function 7-Resource Support Annex .....	ESF 7-1
Emergency Support Function 8-Public Health and Medical Services Annex.....	ESF 8-1
Emergency Support Function 9-Search and Rescue Annex .....	ESF 9-1
Emergency Support Function 10-Oil Spill and Hazardous Materials and Radiation Annex...ESF 10-1	
Emergency Support Function 11-Agriculture Annex.....	ESF 11-1
Emergency Support Function 12-Energy and Utilities Annex.....	ESF 12-1
Emergency Support Function 13-Public Safety and Security Annex .....	ESF 13-1
Emergency Support Function 14-State of Louisiana Disaster Recovery Framework Annex...ESF 14-1	
Emergency Support Function 15-Public Information Annex .....	ESF 15-1
Emergency Support Function 16-Military Support to Civilian Authorities Annex.....	ESF16-1
Emergency Support Function 17-Cyber Incident Response Management Annex.....	ESF 17-1

**SUPPLEMENTS PUBLISHED SEPARATELY:**

1. Louisiana Unified Shelter Plan
2. Peacetime Radiological Response Plan
3. Louisiana Mass Care Feeding Plan
4. State of Louisiana Terrorist Incident Plan
5. State of Louisiana Hazard Mitigation Plan
6. Emergency Support Functions Support Plans
7. Recovery Support Function Support Plans
8. State Administrative Plan for Public Assistance
9. State of Louisiana Influenza Pandemic Operations Plan
10. State of Louisiana EMAC Procedures

11. State of Louisiana Emergency Repatriation Plan
12. Louisiana Volunteerism and Donations Management Plan



EXECUTIVE DEPARTMENT

EXECUTIVE ORDER NUMBER JBE 2022 - 2

---

***EMERGENCY OPERATIONS PLAN***

---

- WHEREAS, the State of Louisiana must be prepared to respond and recover in a coordinated, effective and efficient manner to all the emergencies and disasters to which it is subjected;
- WHEREAS, the State of Louisiana must be organized in such a way as to effectively bring available state, federal, and private resources together to support the response and recovery efforts of our local communities;
- WHEREAS, it is the policy of the State of Louisiana for all homeland security and emergency preparedness functions to follow the principles outlined in the National Incident Management System, or its successor, and La. R.S. 29:722(C); and
- WHEREAS, the State of Louisiana will best achieve effective coordinated emergency planning by updating the state's current emergency operations order through the replacement of Executive Order Number JBE 2019-12, issued on August 9, 2019 and by the Governor's Office of Homeland Security and Emergency Preparedness updating its emergency operations plan.

**NOW THEREFORE, I, John Bel Edwards**, Governor of the state of Louisiana, by virtue of the authority vested by the Constitution and the laws of the state of Louisiana, do hereby order and direct as follows:

- SECTION 1:**
- A. The director of the Governor's Office of Homeland Security and Emergency Preparedness, State of Louisiana, (hereafter "director"), shall direct the State of Louisiana's emergency and/or disaster operations.
  - B. The director, or the director's designee, shall also coordinate the activities of all non-state agencies, departments, and/or organizations involved in emergency management within the State of Louisiana.
- SECTION 2:**
- A. This Executive Order shall constitute the State of Louisiana Emergency Operations Plan ("Plan"), which shall be binding on all departments, commissions, boards, agencies, organizations and employees of the State of Louisiana, and on all local governments or political subdivisions of the state authorized or directed to conduct homeland security and emergency management operations.
  - B. The director shall supplement the provisions of the Plan by prescribing rules, regulations, and procedures. Once adopted, the supplement shall also be binding on all departments, commissions, boards, agencies, organizations and employees of the State of Louisiana, and on all local governments or political subdivisions of the state authorized or directed to conduct homeland security and emergency management operations.
  - C. Any supplement or subsequent changes to the plan shall continue to follow the principles outlined in the National Incident Management System, or its successor, and also provide for the emergency operations that may be

implemented should an emergency and/or disaster strike the State of Louisiana or an area within the State of Louisiana;

- SECTION 3:**
- A. The Director shall control the activation and/or implementation of the Plan and the conclusion and/or deactivation of the Plan.
  - B. The Director shall also control the activation and deactivation of the state Emergency Operations Center (hereafter "Center").
  - C. The activation of the Center shall constitute the implementation of the Plan.

**SECTION 4:** The departments, offices, agencies, and organizations of the State of Louisiana government have primary and support responsibilities for the following Emergency Support Functions (ESF) and Recovery Support Functions (RSF):

ESF	ANNEX	DEPARTMENT/AGENCY	PRIMARY /SUPPORT
<b>ESF 1</b>	Transportation	Department of Transportation and Development	P
		Louisiana National Guard	S
		Department of Agriculture and Forestry	S
		Department of Corrections	S
		Department of Education	S
		Louisiana Department of Health	S
		Louisiana State Police	S
		Department of Wildlife and Fisheries	S
		Department of Children and Family Services	S
		Non-Governmental Organizations (NGO)	S
<b>ESF 2</b>	Communications	Governor's Office of Homeland Security and Emergency Preparedness	P
		Louisiana National Guard	P
		Louisiana State Police	P
		Governor – Division of Administration	S
		Department of Agriculture and Forestry	S
		Department of Corrections	S
		Department of Culture, Recreation & Tourism	S
		Department of Economic Development	S
		Department of Education	S
		Department of Environmental Quality	S
		Governor – Office of Elderly Affairs	S
		Office of the Lieutenant Governor	S
		Louisiana Oil Spill Coordinators Office	S
		Louisiana State University System	S
		Louisiana Department of Health	S
		Department of Justice	S
		Louisiana Workforce Commission	S
		Louisiana Public Service Commission	S
		Louisiana Board of Regents	S
		Department of Revenue	S
Department of Children and Family Services	S		
Department of Transportation & Development	S		
Department of Wildlife and Fisheries	S		
Non-Governmental Organizations (NGO)	S		
<b>ESF 3</b>	Public Works & Engineering	Department of Transportation & Development	P
		Louisiana Coastal Protection and Restoration Authority	P
		Governor – Division of Administration	S
		Louisiana Department of Health	S
		Department of Natural Resources	S
		Department of Environmental Quality	S

		Louisiana National Guard	S
		Non-Governmental Organizations (NGO)	S
<b>ESF 4</b>	Firefighting	Department of Agriculture and Forestry	P
		State Fire Marshal	P
		Louisiana National Guard	S
		Department of Environmental Quality	S
		Department of Transportation and Development	S
		Department of Wildlife and Fisheries	S
		Non-Governmental Organizations (NGO)	S
<b>ESF 5</b>	Emergency Management	Governor's Office of Homeland Security and Emergency Preparedness	P
		Louisiana National Guard	S
		Department of Agriculture and Forestry	S
		Department of Corrections	S
		Department of Culture, Recreation & Tourism	S
		Department of Economic Development	S
		Department of Education	S
		Department of Environmental Quality	S
		Governor - Division of Administration	S
		Governor - Office of Disability Affairs	S
		Governor - Office of Elderly Affairs	S
		Governor - Office of Indian Affairs	S
		Louisiana Oil Spill Coordinators Office	S
		Louisiana State University System	S
		Louisiana Department of Health	S
		Department of Justice	S
		Louisiana Workforce Commission	S
		Department of Natural Resources	S
		Louisiana Public Service Commission	S
		Louisiana Board of Regents	S
		Office of the Lieutenant Governor	S
		Office of the Lieutenant Governor- Volunteer Louisiana	S
		Department of Revenue	S
		Secretary of State	S
		Department of Children and Family Services	S
		Louisiana State Police	S
		Department of Transportation & Development	S
		Department of the Treasury	S
		Department of Wildlife and Fisheries	S
		Louisiana Coastal Protection and Restoration Authority	S
		Department of Public Safety	S
		State Fire Marshall	S
		Non-Governmental Organizations (NGO)	S
<b>ESF 6</b>	Mass Care, Housing and Human Services	Department of Children and Family Services	P
		Louisiana Workforce Commission	P
		Department of Corrections	S
		Governor's Office of Homeland Security and Emergency Preparedness	S
		Louisiana Housing Corporation	S
		Louisiana National Guard	S
		Department of Agriculture and Forestry	S
		Department of Culture, Recreation and Tourism	S
		Department of Economic Development	S
		Department of Education	S
		Department of Environmental Quality	S

		State Fire Marshal	S
		Governor – Office of Disability Affairs	S
		Governor – Office of Elderly Affairs	S
		Louisiana Department of Health	S
		Louisiana State University System and Ag Center	S
		Department of Insurance	S
		Department of Labor	S
		Department of Natural Resources	S
		Louisiana Public Service Commission	S
		Louisiana Board of Regents	S
		Department of Veterans Affairs	S
		Department of Revenue	S
		Department of Transportation and Development	S
		Department of Wildlife and Fisheries	S
		Louisiana State Police	S
		Office of the Lieutenant Governor	S
		State Treasurer	S
		Non-Governmental Organizations (NGO)	S
<b>ESF 7</b>	<b>Resources Support</b>	Governor's Office of Homeland Security and Emergency Preparedness	P
		Louisiana National Guard	P
		Department of Agriculture & Forestry	S
		Department of Culture, Recreation and Tourism	S
		Department of Economic Development	S
		Department of Environmental Quality	S
		Governor – Division of Administration	S
		Louisiana State University System	S
		Louisiana Department of Health	S
		Louisiana Workforce Commission	S
		Department of Natural Resources	S
		Louisiana Board of Regents	S
		Department of Children and Family Services	S
		Louisiana State Police	S
		Office of the Lieutenant Governor	S
		Department of Transportation & Development	S
		Department of the Treasury	S
		Non-Governmental Organizations (NGO)	S
<b>ESF 8</b>	<b>Public Health &amp; Medical Services</b>	Louisiana Department of Health	P
		Louisiana National Guard	S
		Department of Agriculture and Forestry	S
		Department of Corrections	S
		Department of Children and Family Services	S
		Department of Environmental Quality	S
		Louisiana State University System	S
		Louisiana Board of Regents	S
		State Fire Marshal	S
		Louisiana Workforce Commission	S
		Department of Transportation & Development	S
		Department of Veterans Affairs	S
		Non-Governmental Organizations (NGO)	S
<b>ESF 9</b>	<b>Search &amp; Rescue</b>	Department of Wildlife and Fisheries	P
		State Fire Marshal	P
		Louisiana National Guard	S
		Department of Agriculture and Forestry	S
		Louisiana Department of Health	S
		Department of Corrections	S
		Department of Culture, Recreation, & Tourism	S



		Louisiana State Police	S
		Department of Transportation and Development	S
		Louisiana State University Fire and Emergency Training Institute	S
		Department of Revenue - Office of Alcohol and Tobacco Control	S
		Office of the Lieutenant Governor	S
		Non-Governmental Organizations (NGO)	S
<b>ESF 10</b>	Oil Spill, Hazardous Materials and Radiological	Louisiana State Police	P
		Department of Environmental Quality	P
		Louisiana Oil Spill Coordinators Office	P
		Governor's Office of Homeland Security and Emergency Preparedness	S
		Louisiana Coastal Protection and Restoration Authority	S
		Louisiana National Guard	S
		Department of Agriculture and Forestry	S
		State Fire Marshal	S
		Louisiana State University System	S
		Louisiana Department of Health	S
		Department of Natural Resources	S
		Department of Transportation and Development	S
		Department of Wildlife and Fisheries	S
		Non-Governmental Organizations (NGO)	S
<b>ESF 11</b>	Agriculture	Department of Agriculture & Forestry	P
		Louisiana National Guard	S
		Department of Children and Family Services	S
		Department of Corrections	S
		Department of Environmental Quality	S
		Louisiana Department of Health	S
		Louisiana Board of Regents	S
		Louisiana National Guard	S
		Louisiana State Police	S
		Louisiana State University System	S
		Department of Transportation and Development	S
		Governor's Office of Homeland Security and Emergency Preparedness	S
		Department of Wildlife and Fisheries	S
		Southern University and Ag Center	S
		Non-Governmental Organizations (NGO)	S
<b>ESF 12</b>	Energy and Utilities	Department of Natural Resources/Intrastate Natural Gas	P
		Louisiana Public Service Commission/Power	P
		Louisiana Department of Health	P
		Louisiana Department of Environmental Quality (Wastewater Utilities)	S
		Department of Agriculture & Forestry	S
		Louisiana National Guard	S
		Non-Governmental Organizations (NGO)	S
<b>ESF 13</b>	Public Safety and Security	Louisiana State Police	P
		Department of Justice	P
		Department of Agriculture and Forestry	S
		Department of Corrections	S
		Department of Culture, Recreation and Tourism	S

		Louisiana State Police	S
		Department of Transportation and Development	S
		Louisiana State University Fire and Emergency Training Institute	S
		Department of Revenue - Office of Alcohol and Tobacco Control	S
		Office of the Lieutenant Governor	S
		Non-Governmental Organizations (NGO)	S
<b>ESF 10</b>	Oil Spill, Hazardous Materials and Radiological	Louisiana State Police	P
		Department of Environmental Quality	P
		Louisiana Oil Spill Coordinators Office	P
		Governor's Office of Homeland Security and Emergency Preparedness	S
		Louisiana Coastal Protection and Restoration Authority	S
		Louisiana National Guard	S
		Department of Agriculture and Forestry	S
		State Fire Marshal	S
		Louisiana State University System	S
		Louisiana Department of Health	S
		Department of Natural Resources	S
		Department of Transportation and Development	S
		Department of Wildlife and Fisheries	S
		Non-Governmental Organizations (NGO)	S
<b>ESF 11</b>	Agriculture	Department of Agriculture & Forestry	P
		Louisiana National Guard	S
		Department of Children and Family Services	S
		Department of Corrections	S
		Department of Environmental Quality	S
		Louisiana Department of Health	S
		Louisiana Board of Regents	S
		Louisiana National Guard	S
		Louisiana State Police	S
		Louisiana State University System	S
		Department of Transportation and Development	S
		Governor's Office of Homeland Security and Emergency Preparedness	S
		Department of Wildlife and Fisheries	S
		Southern University and Ag Center	S
		Non-Governmental Organizations (NGO)	S
<b>ESF 12</b>	Energy and Utilities	Department of Natural Resources/Intrastate Natural Gas	P
		Louisiana Public Service Commission/Power	P
		Louisiana Department of Health	P
		Louisiana Department of Environmental Quality (Wastewater Utilities)	S
		Department of Agriculture & Forestry	S
		Louisiana National Guard	S
		Non-Governmental Organizations (NGO)	S
<b>ESF 13</b>	Public Safety and Security	Louisiana State Police	P
		Department of Justice	P
		Department of Agriculture and Forestry	S
		Department of Corrections	S
		Department of Culture, Recreation and Tourism	S

		Governor's Office of Homeland Security and Emergency Preparedness (GOHSEP)	S
		Louisiana Board of Regents	S
		Office of Community Development	S
		Louisiana VOAD	S
		Office of the Lieutenant Governor	S
		Governor's Office of Disability Affairs	S
		Governor's Office of Elderly Affairs	S
		Governor's Office – Children's Cabinet	S
		Louisiana Housing Corporation	S
		Louisiana Workforce Commission	S
		Louisiana Board of Regents	S
		Louisiana Department of Corrections	S
		Louisiana Department of Environmental Quality	S
		Louisiana Department of Revenue	S
		Louisiana United Way & 211	S
		Feeding Louisiana	S
<b>RSF 4</b>	<b>Housing</b>	Louisiana Housing Corporation	P
		Department of Children and Family Services	S
		Governor's Office of Homeland Security and Emergency Preparedness (GOHSEP)	S
		Louisiana Economic Development	S
		Louisiana VOAD	S
		Office of the Lieutenant Governor-Volunteer Louisiana	S
		Governor's Office of Disability Affairs	S
		Governor's Office of Elderly Affairs	S
<b>RSF 5</b>	<b>Infrastructure Systems</b>		P
		Department of Transportation and Development	
		Coastal Protection and Restoration Authority	P
		Governor's Office of Homeland Security and Emergency Preparedness (GOHSEP)	S
		Office of Community Development	S
		Office of Financial Institutions	S
		Department of Agriculture and Forestry	S
		Department of Insurance	S
		Public Service Commission	S
		Louisiana Economic Development	S
		Department of Environmental Quality	S
		Department of Natural Resources	S
		Department of Corrections	S
		Department of Public Safety	S
		Louisiana Oil Spill Coordination Officer	S
		Office of the State Fire Marshall	S
		Louisiana Housing Corporation	S
		Louisiana Department of Health	S
		Louisiana Department of Education	S
		Louisiana National Guard	S
		Governor's Office of Disability Affairs	S
		Governor's Office of Elderly Affairs	S
<b>RSF 6</b>	<b>Natural and Cultural Resources</b>		P
		Louisiana Department of Wildlife and Fisheries	
		Coastal Protection and Restoration Authority	P
		Governor's Office of Homeland Security and Emergency Preparedness (GOHSEP)	S
		Department of Natural Resources	S
		Department of Environmental Quality	S

		Department of Culture, Recreation, and Tourism	S
		Department of Agriculture and Forestry	S
		Office of the Lieutenant Governor	S
		Office of Community Development	S
		Secretary of State	S
		Governor's Office of Disability Affairs	S
		Governor's Office of Elderly Affairs	S
<b>ESF 15</b>	Emergency Public Information	Governor's Office of Homeland Security and Emergency Preparedness	P
		Louisiana National Guard	S
		Senate and House Legislative Liaisons	S
		Department of Agriculture and Forestry	S
		Department of Corrections	S
		Department of Culture, Recreation & Tourism	S
		Office of the Lieutenant Governor	S
		Department of Economic Development	S
		Department of Education	S
		Department of Environmental Quality	S
		State Fire Marshal	S
		Governor - Division of Administration	S
		Governor - Office of Disability Affairs	S
		Governor - Office of Elderly Affairs	S
		Governor - Office of Financial Institutions	S
		Governor - Office of Indian Affairs	S
		Louisiana Oil Spill Coordinators Office	S
		Louisiana State University System	S
		Louisiana Department of Health	S
		Department of Justice	S
		Department of Insurance	S
		Louisiana Workforce Commission	S
		Department of Natural Resources	S
		Louisiana Public Service Commission	S
		Louisiana Board of Regents	S
		Department of Revenue	S
		Department of Children and Family Services	S
		Secretary of State	S
		Louisiana State Police	S
		Department of Transportation and Development	S
		Department of the Treasury	S
		Department of Wildlife and Fisheries	S
		Louisiana Coastal Protection and Restoration Authority	S
		Non-Governmental Organizations (NGO)	S
<b>ESF 16</b>	Military Support to Civilian Affairs	Louisiana National Guard	P
<b>ESF 17</b>	Cyber Incident Response Management	Division of Administration	P
		Louisiana National Guard	P
		Governor's Office of Homeland Security and Emergency Preparedness (GOHSEP)	S
		Louisiana State Police-LA SAFE	S
		Department of Justice	S
		Louisiana Board of Regents	S
		LSU-SDMI	S
		Louisiana Optical Network Initiative (LONI Network)	S
		Louisiana Cyber Innovation Center	S
		Office of the Attorney General	S

	Office of the Governor	S
	Office of the Lieutenant Governor	S
	Secretary of State	S
	Department of the Treasury	S
	Louisiana Commissioner of Insurance	S
	Louisiana Department of Health	S
	Department of Agriculture and Forestry	S
	Louisiana Public Service Commission	S
	Louisiana Workforce Commission	S
	Department of Education	S
	Department of Children and Family Services	S
	Department of Wildlife and Fisheries	S
	Department of Natural Resources	S
	Department of Environmental Quality	S

**SECTION 5:** The head of each department, office, agency, and organization identified in Section 4 of this Order shall designate both an emergency coordinator and an alternate coordinator to act on the department's behalf during an emergency situation, and furnish the director with their names and all phone numbers. The head shall also designate a Continuity of Operations Plan (COOP) coordinator who will prepare and maintain plans, procedures, arrangements, and agreements to ensure that the organization will continue to carry out its mission in an emergency or disaster.

**SECTION 6:** The head of each department, office, agency, and organization identified in Section 4 of this Order shall designate both an emergency coordinator and an alternate coordinator to act on the department's behalf during an emergency situation, and furnish the director with their names and all phone numbers. The head shall also designate a Continuity of Operations Plan (COOP) coordinator who will prepare and maintain plans, procedures, arrangements, and agreements to ensure that the organization will continue to carry out its mission in an emergency or disaster.

**SECTION 7:** The head of each department assigned emergency support or recovery support responsibilities in Section 4 of this Order shall assist its primary department in the preparation of their procedures and/or any other documents necessary to support the Plan.

**SECTION 8:** The head of each department assigned a primary and/or a support responsibility in Section 4 of this Order will:

- A. Staff the State Emergency Operations Center and or Joint Field Office with personnel during training exercises and emergencies as requested by the director;
- B. Maintain and operate a 24-hour response capability in the department headquarters, or in the department's designated Emergency Operations Center, when the Plan is implemented;
- C. Participate in exercises of the Plan when scheduled by the Director;
- D. Participate in, and conduct, training essential to implementation of the department's assigned emergency service;
- E. Conduct an annual internal review to update the details of their department's implementing procedures and advise the director of needed modifications of their implementing procedures; and
- F. Maintain logs, records, and reporting systems required by all state and federal laws, rules, and regulations.

**SECTION 9:** All departments, commissions, boards, agencies and officers of the state, or any political subdivision thereof, are authorized and directed to cooperate in the implementation of this Order.

**SECTION 10:** This Order is effective upon signature and shall remain in effect until amended, modified, terminated, or rescinded by the governor or terminated by operation of law.

**IN WITNESS WHEREOF,** I have set my hand officially and caused to be affixed the Great Seal of the State of Louisiana in the City of Baton Rouge, on this 12<sup>TH</sup> day of January, 2022.



  
GOVERNOR OF LOUISIANA

**ATTEST BY THE  
SECRETARY OF STATE**

  
SECRETARY OF STATE

## FOREWORD

This edition of the Louisiana Emergency Operations Plan includes guidance for preparedness and response for the full range of natural, technological, and human-caused All-Hazards events. It conforms to federal law and regulations such as FEMA's Comprehensive Preparedness Guide (CPG) 101 version 2, the National Incident Management System (NIMS), and the Louisiana Homeland Security and Emergency Assistance and Disaster Act as amended.

The mission of the Governor's Office of Homeland Security and Emergency Preparedness is to lead and support Louisiana and its citizens in the preparation for, response to and recovery from all emergencies and disasters. The Governor's Office of Homeland Security and Emergency Preparedness has the responsibility for formulating and updating the State of Louisiana's emergency operations plan, procedures, arrangements and agreements, and for coordinating emergency operations under the direction of the Governor. This Plan provides a general framework, within which State agencies, Parish agencies, volunteer groups, and private organizations can develop detailed Emergency Operations, Continuity of Operations, and Continuity of Government (COG) plans, procedures, arrangements, and agreements.

The planning process is continuous, and improvements and best practices from various exercises and real world incidents are used as the basis for improving and revising the State Emergency Operations Plan. Recipients of this Emergency Operations Plan are expected to develop supplements containing detailed plans, procedures, arrangements, and agreements for their agencies along with a blue print for accomplishing their responsibilities as outlined in this plan; programs to train their personnel to implement those plans, procedures, arrangements and agreements regularly; and make revisions as needed. Each agency assigned as either a primary or support Emergency Support Function or Recovery Support Function should have resources in plans and a means of obtaining resources prior to an emergency or disaster. Changes to this Plan will be issued as appropriate. Supplements to this Plan which deal with particular hazards will be issued periodically. State agencies and parishes should consider addressing, within their plans, citizens with disabilities or functional and access needs wherever applicable. Agencies or organizations which find areas of the Plan that need improvement should advise this office so that changes may be incorporated as efficiently and effectively as possible.

Sincerely,



Casey Tingle  
Director

## SIGNATORIES TO THE STATE OF LOUISIANA EMERGENCY OPERATIONS PLAN



---

Chip Kline  
Chairman  
Coastal Protection and Restoration Authority



---

Dr. Courtney Phillips  
Secretary  
Louisiana Department of Health



---

Honorable Jim Donelon  
Commissioner of Insurance



---

Mr. Jeff Landry  
Attorney General  
Department of Justice



---

Honorable Mike Strain  
Commissioner  
Department of Agriculture & Forestry



---

Mr. Thomas Harris  
Secretary  
Department of Natural Resources



---

Ms. Marketa Garner Walters  
Secretary  
Department of Children & Family Services

---

COL. Lamar A. Davis  
Superintendent  
Louisiana State Police



---

Mr. Don Pierson  
Secretary  
Department of Economic Development



---

Mr. James M. LeBlanc  
Secretary  
Department of Public Safety & Corrections



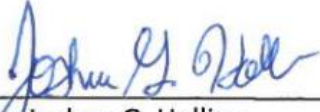

---

Mr. Joshua G. Hollins  
Executive Director  
Louisiana Housing Corporation



---

Ms. Kimberly Lewis Robinson  
Secretary  
Department of Revenue

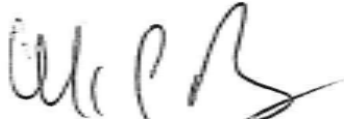

---

Dr. Chuck Carr Brown, Ph.D.  
Secretary  
Department of Environmental Quality



---

Mr. Kyle Ardoin  
Secretary of State  
Department of State



---

Dr. Shawn Wilson  
Secretary  
Department of Transportation and Development



---

Mr. Casey Tingle  
Director  
Governor's Office of Homeland Security &  
Emergency Preparedness



---

Mr. John M. Schroder, Sr.  
State Treasurer  
Department of Treasury



---

Dr. Kim Hunter Reed  
Commissioner  
Louisiana Board of Regents



---

Ms. Juana Lombard  
Commissioner  
Office of Alcohol Tobacco Control

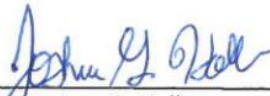

---

Mr. Joshua G. Hollins  
Executive Director  
Louisiana Housing Corporation

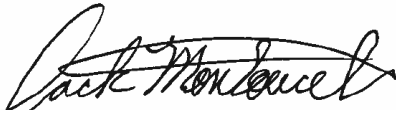

---

Mr. Jack Montoucet  
Secretary  
Department of Wildlife & Fisheries



---

Mr. Marty J. Chabert  
Director  
Louisiana Oil Spill Coordinators Office



---

Mr. Jay Dardenne  
Commissioner  
Division of Administration



---

Mr. Brandon Frey  
Secretary  
Louisiana Public Service Commission



---

Ms. Bambi Polatzola  
Executive Director  
Governor's Office of Disability Affairs



---

Mr. Stanley M. Dameron  
Commissioner  
Office of Financial Institutions



---

Ms. Karen J. Ryder  
Executive Director



---

Ms. Ava Dejoie  
Secretary  
Louisiana Workforce Commission

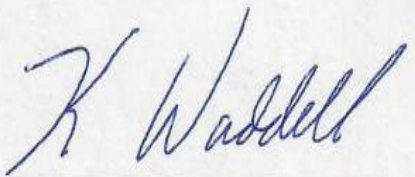

---

MG Keith Waddell  
Adjutant General  
Military Department



---

Lt. Gov. Billy Nungesser  
Lieutenant Governor  
Office of Lieutenant Governor



William Sommers  
Deputy Secretary  
Office of Juvenile Justice



Chief Daniel H. Wallis  
State Fire Marshal  
Office of State Fire Marshal

**RECORD OF CHANGES  
FOR  
STATE OF LOUISIANA  
EMERGENCY OPERATIONS PLAN**

#	As Reads	Page Number	Change to Read	Date
1	EOP Section 4	Pg. 11	Added support organizations for RSF-3	7/27/21
2	ESF-3	Pg. 3-2	Clarification of U.S Army Corps of Engineers	8/10/21
3	ESF-6	Pg. 6-2	Added coordination with partners to assist with housing solutions	7/27/21
4	ESF-6	Pg. 6-5	Added Department of Wildlife and Fisheries to support organizations	7/27/21
5	ESF-6	Pg. 6-5, 6-7, 6-8	Added Southern University System to support organizations	7/27/21
6	ESF-6	Pg. 6-8	Added United Way of Louisiana and 2-1-1 to private relief organizations	7/27/21
7	ESF-8	Pg. 8-3	Clarification that ESF-8 will coordinate with the Cemetery Taskforce before parishes exceed their resources	8/9/21
8	ESF-8	Pg. 8-4	Replaced Surge Ambulance Contract with Plan	7/28/21
9	ESF-8	Pg. 8-4	Added ESF-8 Health and Medical Preparedness Response Network Coalition Plan to ESF-8 Supplements	7/29/21
10	ESF-11	Pg. 11-3	Added Wildlife Services and USDA Office of Homeland Security to USDA departments in ESF-11 support roles	8/6/21
11	ESF-17	Pg. 17-1	Updated for GOHSEP to designate Cyber Incident Response Coordinator and their duties	8/6/21
12	ESF-17	Pg. 17-8, 17-9	Updated ReadyOp to Notification System in Cyber Incident Response	8/6/21
13	Base Plan	Pg. 26	Updated population with 2020 census data	6/8/22
14				
15				
16				
17				
18				
19				

**RECORD OF DISTRIBUTION AND REVIEW  
FOR  
STATE OF LOUISIANA  
EMERGENCY OPERATIONS PLAN**

1.	Reviewed June 2021 to October 2021
2.	Distributed to ESF Leads: June 2021
3.	
4.	
5.	
6.	
7.	
8.	
9.	
10.	
11.	
12.	
13.	
14.	
15.	
16.	
17.	
18.	
19.	
20.	

## **STATE OF LOUISIANA EMERGENCY OPERATIONS PLAN (EOP) BASIC PLAN**

There are three parts to the State Emergency Operations Plan (EOP): The Basic Plan, Functional Annexes and Supplements.

1. **Basic Plan:** The basic plan describes the fundamental systems, strategies, policies, assumptions, responsibilities and operational priorities that Louisiana will utilize to guide and support emergency management efforts. Essential elements of the basic plan include:
  - A description of the emergency and recovery services that are provided by governmental agencies,
  - An outline of the methods for carrying out emergency operations and the process for rendering mutual aid,
  - An overview of the system for providing public information and
  - Emphasis on the need for continuity planning to ensure uninterrupted government operations.

These elements culminate with a comprehensive emergency management concept of operations that outlines the relationships and responsibilities for state government and its political subdivisions.

2. **Functional Annexes:** This plan implements Emergency Support Function and Recovery Support Function working groups and has functional annexes that follow an established format to describe discipline-specific goals, objectives, operational concepts, capabilities, organizational structures and related policies and procedures. The functional annexes are developed separately from the basic plan and will make reference to existing agency and department plans and procedures. Supporting plans and documents from each Emergency Support Function and Recovery Support Function are published separately as Supplement 6 and Supplement 3 respectively to this EOP.
3. **Supplements:** Subsequent plans and procedures that are developed in support of the State Emergency Operations Plan, such as hazard-specific plans, recovery and mitigation plans and related procedures will be incorporated by reference and maintained separate from the basic plan. These supporting supplements are published separately from the State EOP.

### **SUPPLEMENTS PUBLISHED SEPARATELY:**

1. Louisiana Unified Shelter Plan
2. Peacetime Radiological Response Plan
3. Louisiana Mass Care Feeding Plan
4. State of Louisiana Terrorist Incident Plan
5. State of Louisiana Hazard Mitigation Plan
6. Emergency Support Functions Support Plans
7. Recovery Support Functions Support Plans
8. State Administrative Plan for Public Assistance
9. State of Louisiana Influenza Pandemic Operations Plan
10. State of Louisiana EMAC Procedures
11. State of Louisiana Emergency Repatriation Plan
12. Louisiana Volunteerism and Donations Management Plan

## **I. PURPOSE AND SCOPE**

### **A. Purpose**

The purpose of the Louisiana Emergency Operations Plan (EOP) is to establish the policies and structure for state government emergency management. It is a comprehensive, all-hazards approach to all phases of emergencies and disasters: Prevention, Protection, Mitigation, Response, and Recovery. It assigns responsibilities, identifies resources, and defines capabilities in order to save lives, protect property and the environment, and prevent future loss following an incident.

### **B. Scope**

The EOP is designed to coordinate closely with the National Response Framework (NRF) and with Parish Emergency Operations Plans to help meet the National Preparedness Goal. It establishes a base on which further plans, procedures, arrangements, and agreements can be elaborated for preparation against, operation during, and relief and recovery following an incident provided by State and Federal statutes, regulations, executive orders and ordinances, as well as other related or applicable emergency authorities or directives.

The EOP is organized into three parts:

1. Basic Plan
2. Functional Annexes
3. Supplements

## **II. SITUATION AND ASSUMPTION**

### **C. Situation**

1. Louisiana is in the Gulf Coastal Plain and covers an area of approximately 51,000 square miles. Fourteen percent of the land area is covered with water in the form of lakes, rivers, streams, bayous and wetlands. The overall terrain ranges from flat to gently rolling hills; from below sea level in the southern portion to slightly more than 535 feet above sea level at Driskill Mountain in Bienville Parish.
2. The climate is moderate with normally mild, wet winters and warm to hot summers with high relative humidity. Temperatures range from 0 degrees in the winter to near 100 degrees Fahrenheit in the summer. The average annual rainfall varies from 44 inches in the northern part of the state to more than 64 inches in the southern and southeastern areas.
3. The State of Louisiana has sixty-four (64) major political subdivisions called parishes and a population estimated at 4,657,757 (US 2020 Census). Parishes are further subdivided into cities, towns and villages, and are usually governed by a president-council form of government or a police jury headed by a president. Cities, towns and villages have a mayor-council governing body of elected officials. The state is also home to Indian tribes recognized by the Federal government. The tribes are dealt with by the federal government on a government-to-government basis by the Interior Department's Bureau of Indian Affairs. The state encourages close cooperation among tribes, parish governments, and state agencies to ensure the protection of people's lives and property. Further detail is contained in Attachment 4.

4. Louisiana faces a variety of natural, technological, and human caused hazards which pose a significant threat to the people of the state. They include, but are not limited to, hurricanes, severe storms, tornadoes, floods, dam failures, freezes, winter storms, earthquakes, subsidence, erosion, drought, water shortages, wildfires, nuclear power plant incidents, transportation and other hazardous materials (HAZMAT) incidents, industrial accidents, nuclear attack, chemical/biological warfare, terrorist incidents, civil disturbances or riots, cyber-attacks, and resource shortages (utility and energy), or a combination of any of these. These are cataloged in the state's Hazard Mitigation Plan and the State Threat and Hazards Identification and Risk Assessment (THIRA).
5. During an emergency or disaster, the state will take immediate and appropriate action to determine, direct, mobilize, and coordinate resource needs. The state government will suspend or cancel normal operations and redirect resources to save lives, relieve human suffering, sustain survivors, protect property, and repair essential facilities.
6. Many of the potential risks e.g. hurricanes, floods and other severe weather, nuclear facility incidents and enemy attack would be preceded by a period of increased alertness, giving public officials time to take preventive, precautionary or protective measures to reduce loss of life and minimize damages.
7. The state has designed, built, equipped, and staffed an Emergency Operations Center (EOC) from which all state emergency activities will be managed. The state requires all parish governments to have EOC's from which the parishes can manage emergency operations at the parish level and communicate with the state EOC to ensure close cooperation in emergencies and disasters.

#### D. Assumption

1. The state is primarily responsible for natural and technological emergency preparedness, but has a shared responsibility with the federal government for human caused or national security preparedness and for catastrophic natural and technological hazards.
2. The state's responsibility necessitates the development of an all-hazards plan, with functional annexes and detailed procedures, which supports parish and local emergency plans. Planning efforts are made as general as possible to insure flexibility to combat the impact of all types of hazards.
3. The probability of a terrorist or war-related emergency or disaster that would involve mass fatalities and casualties, major devastation and disruption of vital services is low, but it does exist and the consequences would potentially be very high.
4. Emergencies or disasters could, individually or through cascading events, cause a grave emergency condition in any area of the state. Emergencies can vary in scope and intensity, from a small local incident with minimal damage to a multi-parish disaster with extensive devastation and loss of life.



### III. CONCEPT OF OPERATIONS

#### A. General

The Emergency Operations Plan has been developed so that individual Emergency Support Functions (ESF's) and Recovery Support Functions (RSF's) are assigned to State agencies that have been identified as having the personnel, equipment and other resources necessary to effectively support the State of Louisiana during disasters and recovery. The individual tasks within each ESF and RSF should generally parallel the day-to-day functions of the assigned agency(s). It is understood that these responsibilities are in addition to the "mission essential functions" that each agency should identify as part of their Continuity of Operations (COOP) plans. While every effort will be made to accommodate both emergency as well as day to day functions, each state agency understands that support to GOHSEP will take precedence during emergencies.

#### B. Phases of Emergency Management

The State of Louisiana has adopted an "All Hazard's" approach to emergency management that focuses on protecting the lives and livelihoods of all citizens. In order to accomplish this task, the Governor's Office of Homeland Security (GOHSEP) along with both local and Federal partners operates in accordance with the following five (5) phases of emergency management:

1. Prevention – Preventive actions are taken to avoid an incident or to intervene to stop an incident from occurring. Such actions are primarily applicable to terrorist incidents. They may include the application of intelligence and other information to a range of activities that may include deterrence, heightened security for potential targets, investigations to determine the nature and source of the threat, public health and agricultural surveillance and testing, and public safety law enforcement operations aimed at preempting, interdicting or disrupting illegal activities and apprehending perpetrators.
2. Protection – Actions may be taken in advance of an emergency/disaster to protect the citizens, residents, visitors, and critical assets, systems, and networks against the greatest risks to our State in a manner that allows our interests, aspirations, and way of life to thrive. Such measures include, but are not limited to, cybersecurity; access control and identity verification for critical locations and systems; screening, search, and detection of threats and hazards; physical protective measures of critical infrastructure assets; interdiction and disruption of terrorists threats; and risk management for protection programs.
3. Mitigation – Actions may be taken to eliminate or reduce the impact of a disaster. Such measures include zoning and land-use measures, formulating and enforcing building codes that recognize the hazards faced by the community, public education about hazards and protective measures, hazard and vulnerability analysis and preventative health care.
4. Response – Response actions are taken before, during, or after an emergency/disaster to save lives, minimize damages and enhance recovery operations. Such measures include activation of: emergency operation centers, plans and procedures, arrangements and agreements, the emergency alert system, public warning, notification of public officials, provision of mass care, shelter, search and rescue, and security.

5. Recovery – Recovery actions are taken when life and safety are no longer threatened. Such measures include damage assessment, supplemental assistance to individuals and public entities, assessment of plans, procedures, arrangements, and agreements, and the development of economic impact studies and methods to mitigate damages. Long-term recovery focuses on sustainability efforts within affected localities and ways to increase whole community preparedness. Such measures are articulated in ESF-14 and Supplement 7 - Recovery Support Function Plans

### C. National Incident Management System

The Federal Government has adopted the National Incident Management System (NIMS) to manage emergency incidents and disasters from the first responder level to the highest levels of the Federal Government. It is based on the Incident Command System and the Unified Command System (ICS/UCS) and is flexible and appropriate to all types of incidents. The State of Louisiana will use the same flexible structure to manage all types of incidents, particularly those that require the establishment of Incident Command Posts at or near an incident site. The state adopts the NIMS guidance by reference. The operation of the Louisiana Unified Command Group (UCG) is contained in Attachment 6 to this plan.

For the purpose of incident management, State and local governments will utilize the same terminology used by federal agencies:

1. Natural Disaster (National Weather Service)
  - a) Watch
  - b) Warning
  - c) Impact
  - d) Recovery
2. Fixed Nuclear Facility (NRC/FEMA Joint Guidance NUREG-0654, FEMA-REP-1, REV.1.)
  - a) Unusual event
  - b) Alert
  - c) Site area emergency
  - d) General emergency
3. Homeland Security National Terrorism Advisory System (NTAS)
  - a) Elevated Threat – Warns of a credible terrorist threat against the United States
  - b) Imminent Threat – Warns of a credible, specific, and impending terrorist threat against the United States.
4. Cybersecurity Incident Severity Classification as defined by the National Cyber Incident Response Plan
  - a) Level 1 Low- Unlikely to impact to public health or safety, national security, economic security, foreign relations, civil liberties, or public confidence.
  - b) Level 2 Medium- May impact public health or safety, national security, economic Security, foreign relations, civil liberties, or public confidence.
  - c) Level 3 HIGH- Likely to result in a demonstrable impact to public health or safety, national security, economic security, foreign relations, civil liberties, or public confidence.
  - d) Level 4 SEVERE – Likely to result in a significant impact to public health or safety, national security, economic security, foreign relations, or civil liberties

- e) Level 5 EMERGENCY- Poses an imminent threat to the provision of wide-scale critical infrastructure services, national government security, or the lives of U. S. citizens

#### D. Execution and Implementation

The Governor has delegated to the Director of the Governor's Office of Homeland Security and Emergency Preparedness (GOHSEP) the responsibility for implementation of this plan. The Director will implement this plan and procedures when the situation warrants. Should the Governor declare a state of emergency, the plan will automatically be activated under one of four (4) Emergency Activation Levels which are as follows:

1. LEVEL IV – Normal operations are ongoing. GOHSEP staffing is in accordance with authorized manning levels.
2. LEVEL III – Events involve a potential or actual threat to the safety and welfare of the people in a threatened area(s). GOHSEP Crisis Action Team (CAT) is activated and is operational with minimal staffing. The State EOC may be activated with critical ESF's by functional branch.
3. LEVEL II – Events are in progress or have occurred involving an imminent or actual major impact on the safety of the people in a stricken area(s). The SEOC begins 24 hour operations and personnel from both GOHSEP as well as identified state agencies serving as ESF Leads will be required to report to the Independence Blvd. location. In addition, the SEOC activation might warrant the support of selected State, Federal and Volunteer agencies. GOHSEP will continue to monitor the situation and this LEVEL is subject to increase or decrease depending on the current and expected conditions related to the event.
4. LEVEL I – Events are in progress and require all support mentioned in the above four (4) EAL's. All State, Federal and Volunteer organizations mentioned in the Unit Manning Roster (UMR) or hold a seat within the Unified Command Group (UCG) are required to report to the SEOC to support GOHSEP operations on a 24-hour operational period. This status will continue until any potential threat(s) have been eradicated and the emergency is terminated. As the threat or actual danger decreases, proper re-deployment activities will take place so as to allow State Agencies to return to normal operations as quickly and effectively as possible.

### IV. Organization and Assignment of Responsibilities

#### A. Organization

By direction of the Governor, each state department, agency, commission, special district, and board with emergency or disaster responsibilities, along with local government, will have all-hazard emergency operations plans and implementing procedures. All personnel must be trained in their responsibilities and working relationships and must have the authority to respond to emergencies or disasters.

## B. Responsibilities

### 1. Individual Citizens

The residents of Louisiana are the primary beneficiaries of the state's emergency management system. At the same time, residents play an important role in emergency management by ensuring that they and their families are prepared for disasters. Before an emergency, residents can assist the emergency management effort by maintaining supplies and being prepared to evacuate or shelter in-place for several days. Many residents join disaster volunteer programs such as Community Emergency Response Teams (CERT) and remain ready to volunteer or support emergency response and recovery efforts.

During an emergency, residents should monitor emergency communications and carefully follow directions from authorities. By being prepared, residents can better serve their family, their community and reduce demands on first responders.

Many local agencies and parish offices of emergency preparedness have individual, family and community preparedness initiatives. The Governor's Office of Homeland Security and Emergency Preparedness promote individual and community preparedness as part of the **Get a Game Plan** and **Educate to Mitigate** campaigns. These campaigns include television, print and radio media. In addition, two applications have been developed as an easy way for citizens and businesses to access emergency preparedness information on a mobile device. These applications aid families and the business community in the development of a simple but successful game plan by providing current information on what to do, who to call, how to prepare and where to go in the event of an emergency or natural disaster. Additionally, it also contains information for disaster preparedness for people with disabilities and access and functional needs.



### 2. Parish

#### a) Parish President

Pursuant to RS: 29:727 Parish Presidents have overall responsibility for the direction and control of emergency and disaster operations. They direct and establish an office of homeland security and emergency preparedness for their respective parish. Parish Presidents are responsible for declaring a disaster or emergency and filing the declaration promptly with the local clerk of court and the office of emergency preparedness. The declaration of a local emergency will serve to activate the response and recovery program of the local government.

Each Parish President shall appoint a Parish Director of Homeland Security and Emergency Preparedness in accordance with RS 29:728. Each Parish President through the local director must form a Parish Emergency Management Advisory Committee (PEMAC). The PEMAC will provide council on planning, development, prioritization, coordination, and implementation of homeland security and emergency management issues to include but not limited to mitigation, preparedness, response and recovery, grant requests and the expenditure of grant funds.

#### b) Parish Director of Homeland Security and Emergency Preparedness

In accordance with RS: 29: 728, each parish office of homeland security and emergency preparedness shall have a director who is appointed by the parish president of the parish and commissioned by the director of the Governor's Office of Homeland Security and Emergency Preparedness. The director of the parish office of homeland security and emergency preparedness shall have direct responsibility for the organization, administration, and operation of such local organization for homeland security and emergency preparedness subject to the direction and control of the parish president.

c) Parish Office of Homeland Security and Emergency Preparedness

The parish office of homeland security and emergency preparedness shall prepare and maintain an all hazards emergency operations plan (EOP) and keep it current. The EOP must include planning for the humane evacuation, transport, and temporary sheltering of service animals and household pets in times of emergency or disaster. In preparing and revising the plan, the parish office of homeland security and emergency preparedness should embrace the "Whole Community" concept and seek the advice and assistance of government, business, labor, industry, agriculture, civic, and volunteer organizations.

The Office of Homeland Security and Emergency Preparedness shall:

- Determine requirements of the parish and its political subdivisions for food, clothing, and other necessities in the event of an emergency and procure and pre-position supplies, medicines, materials, and equipment for response and recovery.
- Promulgate standards and requirements and for local and inter-jurisdictional disaster plans and periodically review such plans.
- Assist political subdivisions in establishing and operating training programs and programs of information for homeland security and emergency preparedness programs.
- Make surveys of industries, resources, and facilities within the parish, both public and private to create a comprehensive list of all Critical Infrastructure/ Key Resources (CI/KR).
- Plan and make arrangements for the availability and use of any private facilities, services, and property and, if necessary and if in fact used, provide for payment for use under terms and conditions agreed upon.
- Establish a register of persons with types of training and skills important in emergency mitigation, preparedness, response, and recovery.
- Prepare, for issuance by the parish president, executive orders, proclamations, and regulations as necessary or appropriate in coping with disasters or emergencies.

Pursuant to RS 29:727, Parish Presidents have overall responsibility for the direction and control of emergency/disaster operations.

3. State

The governor is responsible for meeting the dangers to the state and people presented by emergencies or disasters, and may issue executive orders, proclamations, and regulations and amend or rescind them. Executive orders, proclamations, and regulations so issued shall have the force and effect of law. The declaration of an emergency or disaster by the governor

shall activate the state's emergency response and recovery program under the command of the director of the Governor's Office of Homeland Security and Emergency Preparedness. (RS 29:724)

a) State Unified Command Group

The State Unified Command Group (UCG), as per RS 29:725.6, is the strategic decision making body for emergencies in the state with the governor serving as the unified commander. The complex array of traditional and emerging threats and hazards demands the application of a unified and coordinated approach to emergency incident management not only during emergencies but during day-to-day operations of state government. The members are established by executive order of the governor. The UCG is responsible for prioritizing initiatives in a state wide emergency response and setting clear goals and objectives, as needed, to address immediate needs in cases of emergencies or disasters. (see attachment 5D)

b) Governor's Office of Homeland Security and Emergency Preparedness Director

The director, subject to the direction and control of the governor, shall be the executive head of the state homeland security and emergency preparedness agency and as such shall be responsible to the governor for carrying out the programs for homeland security and emergency preparedness for the State of Louisiana. He shall coordinate the activities of all agencies and organizations for homeland security and emergency preparedness within the state and shall maintain liaison with and cooperate with homeland security and emergency preparedness agencies and organizations of other states and of the federal government. All state agencies and departments shall comply with directives from the Governor's Office of Homeland Security and Emergency Preparedness relating to emergency planning and operations

The director shall, in addition to other staff, appoint regional coordinators for each homeland security and emergency preparedness region throughout the state, as provided by R.S. 29:726(E) (21) to assist each of the parish offices of homeland security and emergency preparedness

c) Governor's Office of Homeland Security and Emergency Preparedness

The Governor's Office of Homeland Security and Emergency Preparedness, under the governor, shall be responsible for homeland security and emergency preparedness in the state. The office shall prepare and maintain a homeland security and state emergency operations plan (EOP) to assist in the prevention and minimization of injury and damage caused by disaster or emergency and ensure a prompt and effective response and recovery initiative. The EOP must include a proposed post-disaster response and recovery component that contains specific regional and interregional planning provisions and promotes intergovernmental coordination of post-disaster response and recovery activities

Authorization and procedures for the erection or other construction of temporary works designed to protect against or mitigate danger, damage, or loss from flood, conflagration, or other disaster.

Preparation and distribution to the appropriate state and local officials of catalogs of federal, state, and private assistance programs

Prevention of terrorist attacks within this state and reduction of the vulnerability of the homeland to terrorism, minimize the loss of life, injury, and property damage in the state resulting from acts of terrorism, and the coordination of all state and local plans for securing the homeland.

To the extent that sufficient funds are appropriated, the Governor's Office of Homeland Security and Emergency Preparedness shall develop, operate, and maintain a statewide critical incident planning and mapping system for all public buildings in this state to assist first responders when responding to a disaster or emergency. (RS 29:726.3)

#### d) State Agencies

The Governor has the overall responsibility for emergency management in the state and is assisted in these duties by GOHSEP Director as mentioned in LRS 29:724. Tasks for those elements listed which have been given a primary or support shared responsibility for emergency/ disaster situations are contained in Attachment 3A and 3B, Emergency Support Function (ESF) and Recovery Support Function (RSF) Responsibility Charts. General responsibilities for all agencies are as follows:

- Every department, agency or office that has a primary responsibility for an ESF and or RSF will organize, supervise, and coordinate all the activities that take place in that functional area. Primary departments are responsible for specifying the actions of supporting departments and establishing clear coherent requirements that supporting departments can carry out effectively and efficiently.
- Every department, agency, or office that has a support responsibility for an ESF and or RSF will respond as required to carry out the missions that are assigned.

State government departments, agencies, and offices having emergency responsibilities are required to carry out the responsibilities designated in Attachment 3A, State Agency Emergency Support Functions, and 3B State Agency Recovery Support Functions. Depending on its functions, a state agency may have a primary or support role.

State government departments, agencies, and offices which do not have specific ESF/RSF responsibilities will serve as a reserve of material and manpower resources which may be required to perform previously unassigned tasks or supplement other response agencies. They will provide for resource management, direction and control of their personnel, continuity of government (COG), continuity of operations (COOP) and situation intelligence and reporting during emergency/disaster situations.

#### 4. Federal

The United States Federal Emergency Management Agency (FEMA) has the responsibility for the coordination of federal emergency/disaster operations and resources in support of state and local government capabilities, and for directing and coordinating the delivery of federal disaster relief assistance programs. Assistance efforts are organized and coordinated according to the policies and procedures detailed in the National Response Framework (NRF), National Disaster Recovery Framework (NDRF), and the National Incident Management System (NIMS). The Robert T. Stafford Disaster Relief and Emergency Assistance Act (Stafford Act) (Public Law 100-707) is a United States federal law designed to bring an orderly and systemic means of federal natural disaster assistance for state and local

governments in carrying out their responsibilities to aid citizens. The Stafford Act is a 1988 amended version of the Disaster Relief Act of 1974 (Public Law 93-288). It created the system in place today by which a presidential disaster declaration of an emergency triggers financial and physical assistance through the Federal Emergency Management Agency (FEMA). The Act gives FEMA the responsibility for coordinating government-wide relief efforts. The National Response Framework (NRF) includes the contributions of 28 federal agencies and non-governmental organizations, such as the American Red Cross. It is named for Robert Stafford, who helped pass the law. Congress amended it by passing the Disaster Mitigation Act of 2000 (Public Law 106-390), and again in 2006 with the Pets Evacuation and Transportation Standards Act (Public Law 109-308).

## 5. Volunteer and Others

- a) Non-Governmental Organizations (NGO) are generally organized into the Volunteer Organizations Active in Disaster (VOAD) and its Louisiana affiliate, LAVOAD. Such organizations give direct aid and assistance of all kinds to victims of emergencies and disasters.
- b) The American Red Cross (ARC) has a primary response function to mitigate suffering by providing emergency mass care, food, clothing, shelter, first aid, disaster health services and disaster mental health services. The ARC may also provide financial assistance to help with the immediate emergency needs of clients such as; food, clothing or other necessities, information and guidance, problem solving, advocacy and referrals to community and government partners.
- c) The Governor's Office of Homeland Security and Emergency Preparedness may establish a registry of volunteers. Volunteers included in the registry may be deployed by either the Governor's Office of Homeland Security and Emergency Preparedness or the parish office of homeland security and emergency preparedness; if, a Memorandum of Understanding (MOU) has been signed.
- d) The State recognizes the value added in response to the needs of survivors that spontaneous, unaffiliated volunteerism supports. The State approaches volunteerism management as a strategy to engage and support the large numbers of spontaneous local volunteers who wish to help.
- e) Volunteer Louisiana under the Office of the Lieutenant Governor generally assists through [www.volunteerlouisiana.gov](http://www.volunteerlouisiana.gov) to coordinate event-specific spontaneous, unaffiliated volunteers. Volunteer Louisiana supports planning, personnel and equipment to support emergency response and recovery operations in order to aid in the fulfillment of intrastate and interstate mutual aid and Emergency Management Assistance Compact (EMAC) requests, establishing the Volunteer Reception Center (VRC), and cultivating and training strategic relationships to develop local resilience in volunteer management.
- f) Louisiana Department of Health regulates services of Medical Reserve Corp (MRC) volunteers through Louisiana Volunteers in Action (LAVA).
- g) Other volunteer, nonprofit, charitable and religious organizations may provide assistance for registration, identification, medical assistance, shelter, mass feeding, collection of clothing, food commodities, furniture, bedding and cleaning supplies, as



well as cleanup, restoration, temporary repairs and rehabilitation of housing, evacuation, and search and rescue.

- h) Non-Governmental Organizations (NGO) may provide for the immediate cleanup, restoration, temporary repairs, and rehabilitation of residences and vital facilities. At time of warning, they may provide assistance in evacuation and search and rescue.
- i) Radio and communications volunteers affiliated with various communications organizations may be called in to supplement conventional communications systems in emergencies and disasters.

## **V. Direction and Control**

- A. RS 29:724 outlines the powers of the Governor during times of emergency or disaster. The Governor of Louisiana is responsible for the coordinated delivery of all state emergency resources, public, volunteer, and private, during a natural, technological, and/or national security emergency/disaster situation. Pursuant to RS 29:724C (1), the governor has delegated authority to implement this plan and to direct State-level emergency operations through the regularly constituted governmental structure to the Director of GOHSEP.
- B. In the event of an emergency/disaster, the needed elements of state government will be in the State EOC located at 7667 Independence Boulevard in Baton Rouge. Should the primary EOC become inoperative, isolated, and/or unusable, GOHSEP Director shall issue relocation instructions to deployment teams for the preparation of the alternate state EOC.
- C. Each state department or agency shall be under the general control of its respective Secretary/Director, etc., through his or her designated emergency representative. The emergency representative shall be empowered to make decisions and expend resources (personnel, materials, supplies, equipment, facilities, and funds) in providing operational and technical support to state and local governments during any emergency/disaster incident.
- D. Local governments are responsible under all applicable laws, executive orders, proclamations, rules, regulations and ordinances for emergency management within their respective jurisdiction. Local emergency management organizations shall function from designated EOC's and are subject to the direction and control of the executive heads of government, in coordination with the Governor and GOHSEP Director.
- E. Upon activation of the State EOC, GOHSEP staff and state agencies shall insure that the necessary personnel and resources are available. Those agency representatives should bring or have pre-positioned plans, procedures, resource inventories, supplies and notification lists needed to facilitate emergency/disaster operations.

## **VI. Continuity of Government/Continuity of Operations**

- A. Disasters can interrupt, paralyze, and/or destroy the ability of state, or local governments to carry out their executive, legislative, and judicial functions. Therefore, it is imperative that each level of government build this capability to preserve, maintain, and/or reconstitute its ability to function under the threat or occurrence of any emergency/disaster that could disrupt governmental operations and services.
- B. To have an effective comprehensive emergency management system, operations depend upon Continuity of Government (COG) and Continuity of Operations from the highest to the lowest level: (1) lines of succession for officials and (2) the preservation of records which are essential

to the effective functioning of government and for the protection of rights and interests of the state and its citizens under emergency conditions.

- C. The Louisiana Constitution Article IV vests in the Governor the chief executive power of the state. It establishes the emergency powers of the Governor and provides for the line of succession, which is:
  - 1. Governor
  - 2. Lieutenant Governor
  - 3. Secretary of State
  - 4. Attorney General
  - 5. Treasurer
  - 6. Presiding Officer of the Senate
  - 7. Presiding Officer of the House of Representatives
  
- D. The legislature has enacted Acts 111, 112, 113 and 114 of 1963, all which mandate the designation of no less than three nor more than seven emergency interim successors for the State Executive, Judicial, Legislative and Local Executive branches of government, respectively.
  
- E. All department heads shall designate a primary and two (2) alternate interim emergency successors, as a minimum, for key supervisory positions, which will ensure the continuance of the leadership, authority, and responsibilities of their departments. Each agency/office head shall further designate a primary and alternate interim emergency successor for key positions.
  
- F. Designated emergency successors shall be instructed on their responsibilities, order of succession, when they will assume these positions, and when they will be terminated. Normally, an interim emergency successor may assume leadership whenever the incumbent becomes unavailable to perform their functions or when requested to do so during periods of emergencies/disasters. They shall hold these positions until relieved by the incumbent or the emergency/disaster has been brought to a successful conclusion. Agencies will avoid the practice of designating key officials to succeed each other. Agencies will set up a system for internal status reporting on manpower and other resources, estimates of damages, and actions taken to deal with emergencies.
  
- G. Each agency shall develop and maintain Continuity of Operations Plans (COOP) that describe the plans, procedures, arrangements and agreements by which agencies can overcome emergencies that could inflict major damages on their normal facilities, staff, records, equipment and communications, and continue to provide services for the state and its people. The agencies will update and maintain departmental emergency operating procedures that prescribe in detail how the department or office will operate in an emergency, including notification of key personnel, setting up 24-hour shifts and other measures.
  
- H. Each agency head or his/her primary assistant shall insure essential records and documents required for COG and COOP are properly stored, classified, indexed, filed and segregated from non-essential documents. Insure the maintenance and safeguarding of key records and documents through the use of duplicate files in dispersed locations or other measures.
  
- I. The records and documents which require safeguarding fall into three (3) general types: (1) records that protect the rights and interests of individuals; vital statistics, land and tax records, license registers, articles of incorporation, etc.; (2) records required for effective emergency

operations; plans, procedures, resource inventories, lists of succession, maps, memoranda of understanding, agreements and lists of regular and auxiliary personnel; (3) records required to re-establish normal governmental functions and protect the rights and interests of government; federal/state laws, statutes, constitutions, charters, executive orders, proclamations, rules and regulations, official proceedings, financial and court records.

- J. Duplicate records and documents of the three (3) general types will be made on a continuing basis. Duplicates will be stored at a dispersed location, designated by the Department Head.
- K. Key supervisory personnel and interim emergency successors will be informed as to the location and content of the dispersed records and/or documents. Procedures shall be formulated for the retrieval of those records and documents from the dispersed site during periods of national security and other catastrophic emergencies/disasters, should they be required.

## **VII. Administration and Logistics**

- A. During an emergency/disaster, after the State of Emergency has been declared by the Governor, laws and/or administrative procedures may be suspended by Executive Order(s) of the governor.
- B. State and local response elements will include provisions for documenting all emergency/disaster related expenditures using generally accepted accounting procedures as outlined in the State's Administrative Plan. Receipts, invoices, purchase orders, rental agreement, etc., will serve as a basis for settlement of claims and will support the state's request for supplemental federal assistance.
- C. When an emergency/disaster occurs, rapid steps will be undertaken to assess deaths and injury to persons and damage to private and public property. After local and neighboring resources have been exhausted, assistance requests shall be submitted to GOHSEP.
- D. There exist several different communication systems between Local, State, Federal, and Private Organizations for the coordination and direction of emergency/disaster relief efforts. These systems are composed of internal and/or external systems located in GOHSEP, the local EOC's or other First Responder agencies.
- E. During increased readiness periods, each state EOC emergency representative and local government shall ensure that property, personnel, supplies, equipment and vehicles are accounted for and protected and, if necessary, dispersed to a designated area and maintained in operational condition at all times.
- F. All elements of state and local government agencies shall implement resource controls to determine the availability and accessibility of required resources. Further, they shall identify any additional requirements needed to support emergency/disaster operations.
- G. Funding to meet the needs of emergencies and disasters may be available if appropriate local, parish, state and Federal disaster declarations are made. The first recourse shall be to use funds regularly appropriated to state agencies. If the demands exceed available funds, the governor may make additional funds available with the concurrence of the Interim Emergency Board.
- H. Training of emergency operations staff will be conducted annually through in-house sessions, exercises, actual operations, or GOHSEP/DHS/FEMA sponsored classes. During increased readiness conditions, accelerated/refresher training on operations and radiological preparedness will be conducted for EOC staff by the respective state/local training officer.

- I. Pursuant to federal law, the Director of GOHSEP, on behalf of the Governor, may request federal assistance through the US DHS/FEMA.

## **VIII. Plan Development and Maintenance**

- A. The Governor, pursuant to RS 29:726, has directed the Director of GOHSEP to develop and maintain Louisiana's Emergency Operations Plan (EOP). The Director of GOHSEP shall be responsible for the state's emergency preparedness and homeland security planning efforts. The director has been delegated the authority to implement the EOP as necessary and will provide the necessary assistance, guidance, and coordination to ensure that the EOP addresses an all-hazard approach, including natural, technological and/or a national security emergency or disaster situation, and is flexible enough to allow users to adjust to emergency situations.
- B. The various state departments, agencies, special districts, commissions, boards, volunteer and private sector groups with emergency responsibilities shall integrate their operational, COG and COOP efforts in the development, maintenance, implementation and testing of this EOP and its procedures. Local government has been tasked to develop, implement, and maintain EOP's and shall adhere to policies and tasks outlined within this EOP.
- C. All plans, annexes, appendices, implementing procedures and resource (personnel, equipment, supplies, and facilities) inventories shall be based on those potential hazards to which the state is subject, along with the support needed to assist local government before, during, and after any emergency/disaster incident. Plans, annexes, appendices, and procedures will detail who, what, when, where and how emergency tasks and responsibilities will be conducted.
- D. This EOP, its annexes, appendices, procedures, resource inventories, and notification/recall lists shall be maintained and kept current by all parties in the following manner: The EOP and its annexes and appendices, COG and COOP provisions will be reviewed every year, with a comprehensive review and update every four (4) years. Any agency changes or additions will be forwarded to GOHSEP by 31 March every year. Resource inventories and notification/recall lists should be reviewed on a six (6) month basis or as changes occur. Procedures will be reviewed following critiques of actual emergency/disaster operations and/or exercises, where deficiencies were noted.
- E. Major changes that affect the "Situation and Assumptions", "Concept of Operations", "Assignment of Responsibilities", and "Direction and Control" will be made as required. Major changes shall be approved by the respective department head. The emergency representative has the authority to revise and/or update routine changes, i.e., implementing procedures, resource inventories, and notification/recall lists.
- F. All changes, revisions and/or updates shall be forwarded to GOHSEP for review, editing, publication and distribution. If no changes, revisions, and/or updates are required, GOHSEP shall be notified in writing by the respective department head that plan, appendices, procedures, etc., have been reviewed and are considered valid and current, signed by the respective department head.

## **IX. Authorities and References**

- A. Federal
  1. Public Law 93-234, as amended The Flood Disaster Protection Act of 1973.
  2. Public Law 93-288, The Disaster Relief Act of 1974, as amended by Public Law 100-707, The Robert T. Stafford Disaster Relief and Emergency Assistance Act of 1988.
  3. Title 44, The Code of Federal Regulations, Part 206.

4. Federal Emergency Management Agency, FEMA-64, Emergency Action Planning Guidelines for Dams, 1985.
5. Federal Emergency Management Agency, CPG 101 Comprehensive Preparedness Guide
6. National Preparedness System
  - a) National Prevention Framework
  - b) National Protection Framework
  - c) National Mitigation Framework
  - d) National Response Framework
  - e) National Disaster Recovery Framework
7. National Incident Management System ( NIMS)
8. All other Public Laws or Executive Orders enacted or to be enacted which pertain to emergencies/disasters
9. Federal Emergency Management Agency, Comprehensive Preparedness Guide (CPG) 101, Producing Emergency Plans, Interim Version 2.0

#### B. State

1. The Louisiana Homeland Security and Emergency Assistance and Disaster Act of 1993 as amended
2. Act 111, Emergency Interim State Executive Succession Act of 1963
3. Act 112, Emergency Interim Judicial Succession Act of 1963
4. Act 113 as amended, Emergency Interim Legislative Succession of 1963
5. The Louisiana State Administrative Plan dated 1992, as amended
6. Louisiana Significant/High Hazard Dam Safety Plan 1989
7. State Executive Order included in the preface to this plan
8. Louisiana Disaster Recovery Manual dated January 2005, as amended
9. State of Louisiana Threat and Hazard Identification and Risk Assessment
10. Other Acts, Executive Orders, Proclamations, Compacts, Agreements, and Plans pertaining to emergencies and/or disasters that has been or will be developed or enacted

#### C. Local

1. Ordinances or resolutions enacted or to be enacted pursuant to requirements of the authorities cited in Paragraph A and B above as they pertain to emergencies/disasters.
2. Act 114, Emergency Interim Local Executive Succession Act of 1963
3. Local Emergency Operations Plans
4. Mutual Aid, Letters of Agreement, and or Memorandums enacted or to be enacted

#### D. Volunteer

1. Louisiana Revised Statutes, Chapter 29:650, Civil Air Patrol
2. Act 58-4-1905, American Red Cross (ARC). Mennonite Disaster Services/FEMA Agreement. Salvation Army Charter, May 12, 1974 and Memorandums of Understanding between Louisiana and the agencies above
3. Other directives as appropriate

## X. Glossary/Definitions of Terms

The following is a glossary of terms, acronyms, abbreviations and definitions that are used in this plan and are unique to emergency/disaster operations.

Congregate Care Facilities – Public or private buildings in a reception area that may be used to lodge and care for evacuees

CTNS – Critical Transportation Needs Shelter

D&C – Direction and Control

Disaster – Any occurrence or imminent threat of widespread or severe damage, injury, or loss of life or property resulting from a Natural, Technological, and/or National Security incident, including but not limited to earthquake, explosion, fire, flood, high water, hostile military actions, hurricanes, landslide, mudslide, storms, tidal wave, tornadoes, wind driven water or other disasters.

Disaster Recovery Manager – Official appointed by the Director of GOHSEP to coordinate post disaster recovery activities

Emergency Action Level (EAL) – A system that classifies the seriousness of an emergency/disaster situation. There are four (4) levels: LEVEL IV, LEVEL III, LEVEL II and LEVEL I. The state may escalate to a more serious class if conditions deteriorate or are expected to deteriorate. The state may de-escalate to a less serious class if response actions have resolved the situation.

- A. LEVEL IV – Normal operations are ongoing. GOHSEP staffing is in accordance with authorized agency manning levels.
- B. LEVEL III – Events involve a potential or actual threat to the safety and welfare of the people in a threatened area(s) and has the potential of escalating.
- C. LEVEL II – Events are in progress or have occurred which involve an imminent or actual major impact on the safety of the people in a stricken area(s).
- D. LEVEL I – Events that are in progress which continue previously declared action levels and to initiate those actions that begin to lead the return of stricken area(s) back to a state of normalcy and pre-disaster design and use.

Emergency Alert System (EAS) – A network of broadcast stations and interconnecting facilities which have been authorized by the Federal Communications Commission to operate in a controlled manner during a state of public disaster or other natural emergency, as provided by the Emergency Broadcasting System Plan.

Emergency Operations Center (EOC) – A protected site from which public officials issue warnings and exercise direction and control during an emergency/disaster. It is equipped and staffed to provide support in coordinating and guiding emergency/disaster operations

EOP – Emergency Operations Plan

EPI – Emergency Public Information

ESF –Emergency Support Functions

FCO – Federal Coordinating Officer

DHS/FEMA – The Federal Department of Homeland Security/Federal Emergency Management Agency

Governor’s Authorized Representative (GAR) – The person named by the governor in the Federal-State Agreement (normally GOHSEP director or his designee) to execute on behalf of the state all necessary documents for disaster assistance following a declaration of an emergency or major disaster, including certification of applicants for public assistance

GOHSEP – Governor’s Office of Homeland Security and Emergency Preparedness

Hazardous Material (HAZMAT) – Any substance or material in a quantity or form which may be harmful or injurious to humans, domestic animals, wildlife, economic crops, or property when released into the environment. The four traditional classes are: chemical, biological, radiological, explosive. A comprehensive listing of substances can be found in 49CR172.101.

Implementing Procedures (IP's) – A set of instructions having the force of a directive, covering those specific actions which lend themselves to a definite or standardized procedure without loss of effectiveness during the conduct of emergency/disaster operations

JIC – Joint Information Center

Local Government – Any parish, city, town, village or other legal political subdivision within the state of Louisiana.

MIEP – Medical Institution Evacuation Plan

MSNS – Medical Special Needs Shelter

National Disaster Recovery Framework (NDRF) - guidance that enables effective recovery support to disaster-impacted States, Tribes and local jurisdictions.

National Security Emergency – Events include nuclear, conventional, chemical, biological warfare, civil disorder, terrorism and/or energy shortages

Natural – Events include floods, hurricane/tropical storm, erosion, drought, tornado, wildfire, earthquake subsidence, dam failure, severe storms and winter storm/freeze

PSA – Public Service Announcement

RSF – Recovery Support Function

Resources – Include materials (raw, basic, or finished), supplies, equipment, manpower, facilities, services, finished goods and products

SAR – Search and Rescue

SART – State Animal Response Teams

State – Generically, the term state is used to include the political subdivisions, boards, special districts, commissions and Indian tribes or authorized tribal organizations

State Coordinating Officer (SCO) – The state official designated by the Governor to act as principal assistant in the coordination and supervision of the Disaster Assistance Program and to act in cooperation with the Federal Coordinating Office (FCO) for the purpose of coordinating disaster assistance efforts with those of the Federal government

Technological – Events include hazardous materials (stationary and transportation), nuclear power facility, transportation accidents and power failure

USAR – Urban Search and Rescue

## **XI. ATTACHMENTS TO BASIC PLAN**

Attachment 1 – State Organizational Chart

Attachment 2 – List of Potential Hazards

Attachment 3A – State Agency Emergency Support Function (ESF) & Responsibility Chart

Attachment 3B – State Agency Recovery Support Function (RSF) & Responsibility Chart

Attachment 4 – Tribal Relations

Attachment 5 – Resource Request Flow Chart

Attachment 5A – Parish Level Resource Request Flow Chart

Attachment 5B – State Level Resource Request Flow Chart

Attachment 5C – Unified Command Structure Chart

Attachment 5D – Unified Command Group Chart



**ATTACHMENT 1  
STATE ORGANIZATIONAL CHART**

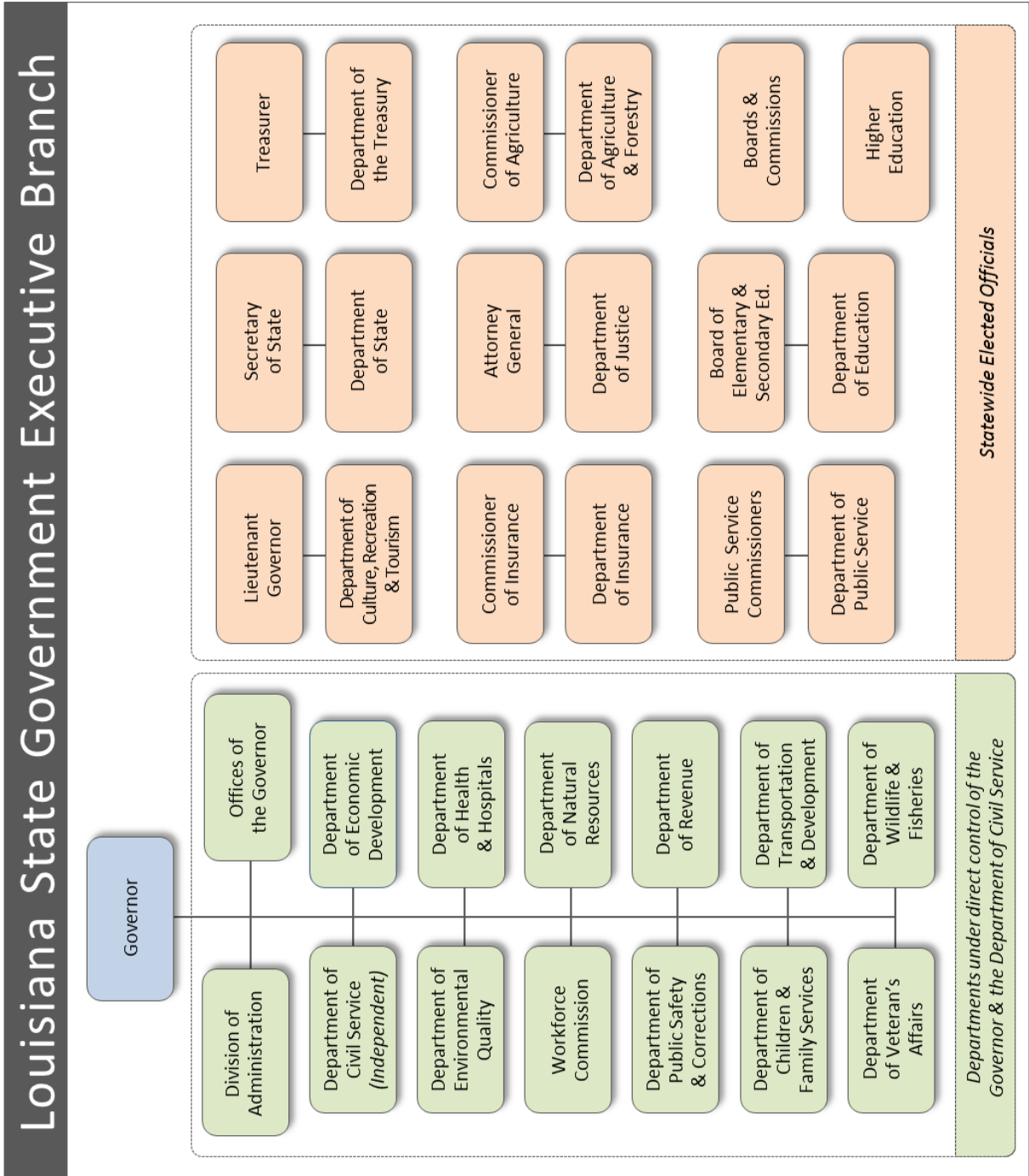

## ATTACHMENT 2 HAZARDS AND VULNERABILITIES

79 disasters have occurred in Louisiana from 1953-2017.

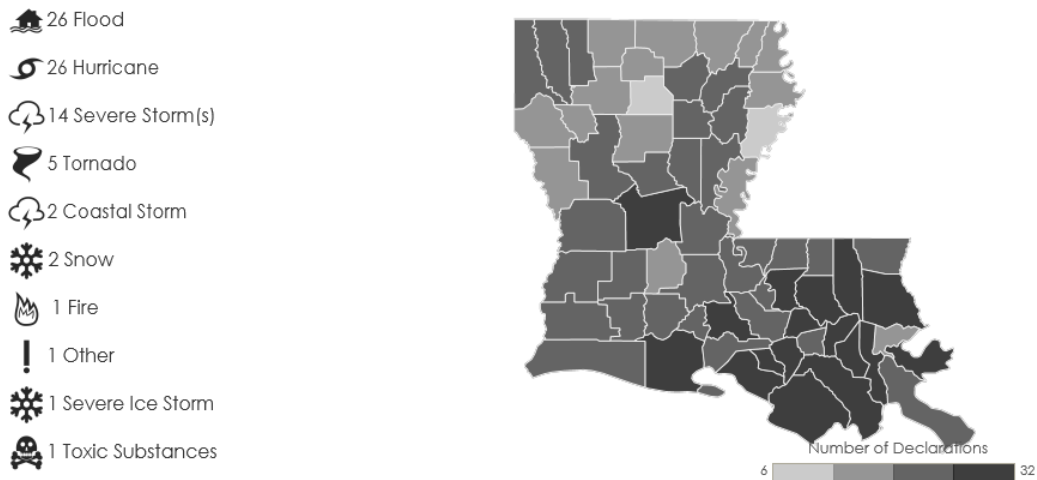

The State will conduct a Threat and Hazard Identification and Risk Assessment (THIRA) **annually** to identify the threats and hazards Louisiana citizens will most likely face. The THIRA is a four step process intended to inform the whole community about its risks and what is needed to address those risks. It allows the State to better understand its threats and hazards and how the impacts may vary according to time of occurrence, season, location, and other community factors. The THIRA will assist the State in creating informed and defensible capability targets for each of the 32 Core Capabilities identified in the National Preparedness Goal, as well as, the resource requirements necessary to address anticipated and unanticipated risks. The THIRA should be used to support a host of activities such as: capability estimation and required resource planning; mutual aid planning; identifying opportunities to lessen the impact of potential emergencies or disasters; and informing resource allocation within a community. The information can be shared with neighboring jurisdictions and may present opportunities to share best practices or resources.

In addition to the THIRA, the State will complete a Stakeholder Preparedness Report (SPR). The SPR assesses the current capability against the capability targets and documents any gaps that exist.

Louisiana's geographic location, industrial and population distribution subject the state and its people to a variety of hazards. The following list includes, but is not limited to, the most serious likely hazards, separated into natural, technological, human-caused and biological categories:

1. Natural Hazards:
  - a) Coastal Erosion
  - b) Drought
  - c) Earthquake
  - d) Flood
  - e) Fog
  - f) Hailstorm
  - g) Hurricanes (Tropical Cyclone)

- h) Ice Storm
- i) Severe Storms, including lightning and high winds (Thunderstorms)
- j) Subsidence
- k) Severe Summer Weather/Extreme Heat
- l) Storm Surge
- m) Tornado
- n) Wildfire

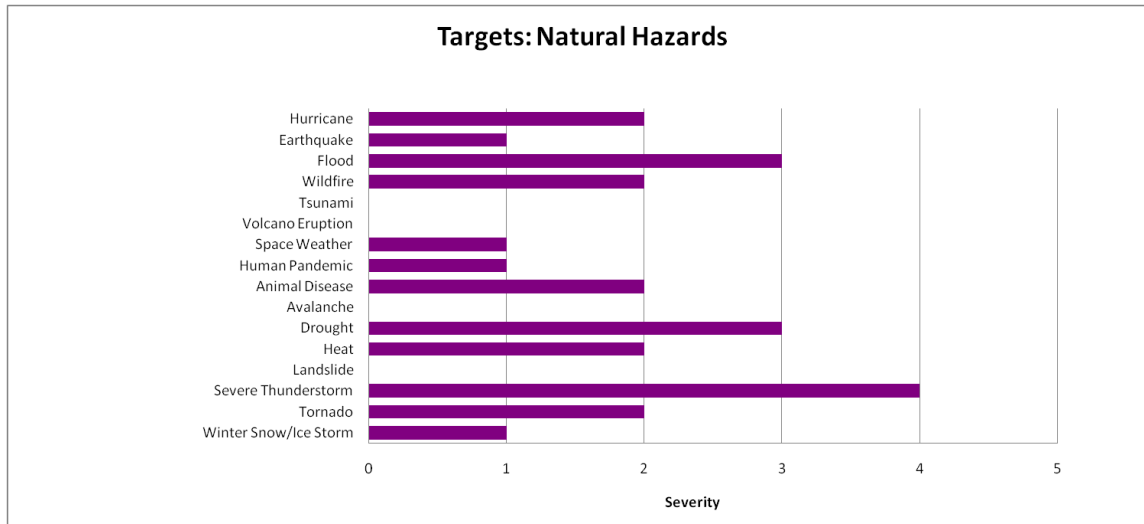

2. Technological Hazards:

- a) Airplane Crash
- b) Dam Failure
- c) Levee Failure
- d) Hazardous Materials Fixed Facility Incident
- e) Hazardous Materials Transportation Incident
- f) Nuclear Fixed Facility Incident
- g) Nuclear Transportation Incident
- h) Offshore Oil Spill
- i) Utilities Failure (Energy)
- j) Utilities Failure (Telecommunications)
- k) Utilities Failure (Sewer and Water Systems)

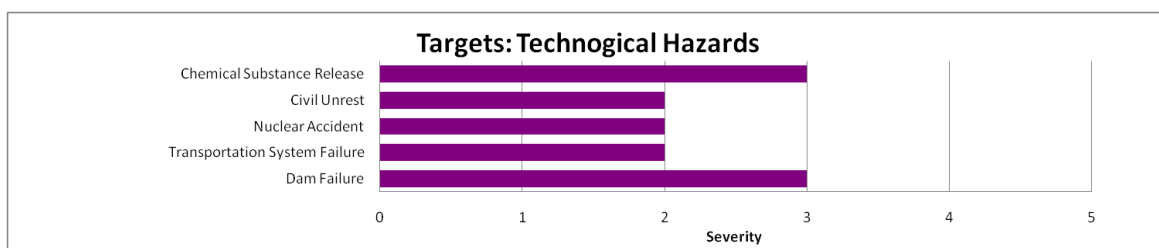

3. Adversarial Threats:

- a) Civil Disorder
- b) Terrorist/Enemy Attack
- c) Cyber Terrorism

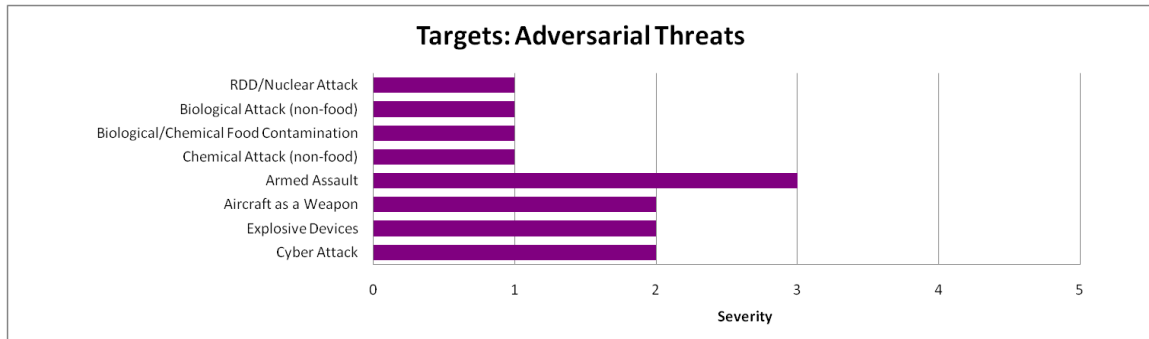

4. Biological Hazards:

- a) Animal Disease
- b) Pandemic Infectious Disease

ATTACHMENT 3A  STATE AGENCY EMERGENCY SUPPORT FUNCTION (ESF) & RESPONSIBILITY CHART																	
	ESF #1 – Transportation	ESF #2 – Communications	ESF #3 – Public Works and	ESF #4 – Firefighting	ESF #5 – Emergency	ESF #6 – Mass Care, Emergency Assistance	ESF #7 – Resources Support	ESF #8 – Public Health and	ESF #9 – Search and Rescue	ESF #10 – Oil Spill, Hazardous	ESF #11 – Agriculture	ESF #12 – Energy and Utilities	ESF #13 – Public Safety and	ESF #14 – See Recovery Support Functions Chart	ESF #15 – Emergency Public	ESF #16 – Military Support To Civilian Authorities	ESF# 17-Cyber Incident Management
Governor’s Office of Homeland Security and Emergency Preparedness		P			P	S	P			S	S				P		S
Louisiana Coastal Protection and Restoration Authority			P		S					S					S		S
Department of Agriculture and Forestry	S	S		P	S	S	S	S	S	S	P	S	S		S		S
Department of Corrections	S	S			S	S		S	S			S			S		
Department of Culture, Recreation and Tourism		S			S	S	S		S				S		S		S
Department of Economic Development		S			S	S	S								S		S
Department of Education	S	S			S	S									S		S
Department of Environmental Quality		S	S	S	S	S	S			P	S	S			S		S
Louisiana Department of Health	S	S	S		S	S	S	P	S	S	S	P			S		S
Department of Insurance						S									S		S
Department of Justice		S			S	S							P		S		S
Department of Labor						S											S
Department of Natural Resources			S		S	S	S			S		P			S		S
Department of Revenue		S			S	S									S		S
Department of Children and Family Services	S	S			S	P	S	S			S				S		S
Department of Transportation and Development	P	S	P	S	S	S	S	S	S	S	S		S		S		S
Department of Treasury					S	S	S								S		S
Department of Veterans Affairs						S		S									
Department of Wildlife and Fisheries	S	S		S	S	S			P	S	S		S		S		S
Division of Administration		S	S		S		S								S		P
Office of Disability Affairs					S	S									S		
Office of Elderly Affairs		S			S	S									S		
Office of Financial Institutions															S		S
Office of Indian Affairs					S										S		
Office of the Lieutenant Governor		S			S	S	S		S				S		S		S
Office of the Lieutenant Governor-Volunteer Louisiana					S												
Louisiana Oil Spill Coordinator’s Office		S			S					P					S		
Louisiana Board of Regents		S			S	S	S	S			S				S		S
Louisiana Housing Corporation						S											
Louisiana National Guard	S	P	S	S	S	S	P	S	S	S	S	S	S		S	P	P
Office of Juvenile Justice													S				
Louisiana Public Service Commission		S			S	S						P			S		S
Louisiana State Police	S	P			S	S	S		S	P	S		P		S		S

Louisiana State University System		S			S	S	S	S		S	S				S		S
LSU Fire & Emergency Training Institute									S								
Louisiana Workforce Commission		S			S	P	S	S							S		S
Office of Alcohol and Tobacco Control									S				S				
Non-Governmental Organizations (NGO)	S	S	S	S	S	S	S	S	S	S	S	S			S		
Secretary of State					S										S		S
Senate and House Legislative Liaisons															S		
Southern University System						S					S						
State Fire Marshal				P	S	S		S	P	S			S		S		
University of Lafayette NIMSAT/BOEC							S										

**Key:** P = Primary S = Support Some associations and organizations are not listed in this chart. They are listed in the ESF Annexes. As of October 2021

**ATTACHMENT 3B**  
**ESF #14 STATE OF LOUISIANA DISASTER RECOVERY FRAMEWORK- RECOVERY SUPPORT FUNCTIONS**  
**AND RESPONSIBILITY CHART**

Recovery Support Functions and Responsibility Chart	Community Planning and Capacity Building	Economic	Health and Social Services	Housing	Infrastructure Systems	Natural Resources
Coastal Protection and Restoration Authority					P	P
Department of Agriculture and Forestry	S	S			S	S
Department of Children and Family Services			P	S		
Department of Culture, Recreation, and Tourism						S
Department of Education			P			
Department of Environmental Quality					S	S
Louisiana Department of Health			P			
Department of Insurance	S	S			S	
Department of Natural Resources					S	S
Department of Public Safety					S	
Department of Revenue	S	S				
Department of Transportation and Development					P	
Department of Wildlife and Fisheries						P
Office of Financial Institutions	S	S			S	
Governor’s Office of Homeland Security and Emergency Preparedness	S	S	S	S	S	S
Louisiana Board of Regents			S			
Louisiana Economic Development	S	P			S	
Louisiana Housing Corporation				P		
Louisiana State University			S			
Louisiana State University/SDMI	S	S				
Louisiana Oil Spill Coordination Officer					S	
Louisiana Workforce Commission	S	S				
Office of Community Development	P			S		
Office of the Lieutenant Governor	S					S
Office of the Lieutenant Governor –Volunteer Louisiana	S			S		
Public Service Commission					S	
Secretary of State						S
State Fire Marshal					S	
University of Louisiana at Lafayette NIMSAT/BEOC	S	S				
Non-Governmental Organization (NGO)*						S

# ATTACHMENT 4 TRIBAL AFFAIRS

## I. PURPOSE AND SCOPE

This attachment recognizes the status of Indian tribes located in Louisiana and outlines the policies that the state and parishes will follow in order to ensure that the members of the tribes are afforded the opportunity to participate in and benefit from the state and parish Homeland Security and Emergency Preparedness policies, programs and activities.

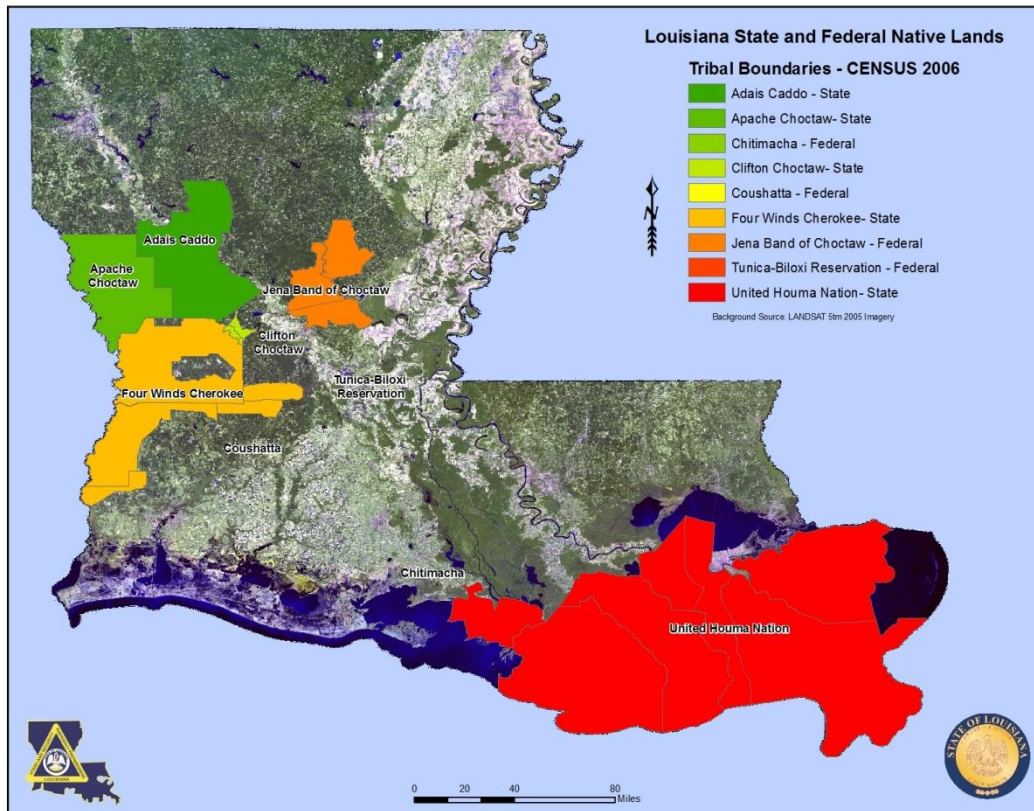

## II. SITUATION

The federal government recognizes Indian tribes as self-governing “sovereign domestic dependent nations,” and deals with them on a “government-to-government basis.” The federal government recognizes the right of Indian tribes to deal directly with state and local government officials. Several such federally recognized tribes are situated in Louisiana. The Governor’s Office of Indian Affairs (GOIA) maintains a cooperative relationship with the states’ tribes, both federal and state recognized. Tribes may deal directly with parish governments in order to coordinate their emergency operations planning and operations for mutual benefit.

## III. CONCEPT OF OPERATIONS

### A. General:

The state will encourage tribes and parishes to work together to coordinate planning and operations, since most emergencies arise at the parish or local level.



B. Mitigation:

GOHSEP and Parish OHSEP will make emergency operations plans, procedures, agreements and arrangements available to Indian tribes on a direct, government-to-government basis.

C. Prevention:

1. GOHSEP will invite tribes to participate in state level emergency planning, training and exercises
2. Parishes will invite tribes to join in emergency planning, training and exercises
3. The state and parish governments will execute such mutual aid agreements with tribes as are mutually advantageous

D. Response:

1. When emergencies arise, state and parish OHSEP will transmit emergency information and warnings to tribal authorities and coordinate activities, such as evacuation and sheltering
2. As emergencies progress, tribal people residing within the boundaries of sovereign land will be given the same level of life saving and sustaining support as the other citizens of the state
3. Parish and state governmental organizations will work with the tribes and the GOIA to ensure the status of tribal citizens is accounted for and reported

E. Recovery:

When an emergency or disaster has ended, parish and state authorities will work to the best of their ability with tribal authorities to arrange for the restoration of tribal citizens to their pre-emergency status

#### **IV. ORGANIZATION AND ASSIGNMENT OF RESPONSIBILITIES**

Indian tribes may deal with federal, state, and parish governmental bodies on a government-to-government basis. The GOIA is responsible for overall liaison and coordination with the tribes.

#### **V. DIRECTION AND CONTROL**

Indian tribes are independent entities under their own control, and are not subordinate to state or parish authorities. They may take such advice and direction in an emergency as they have previously agreed for the safeguarding of the lives and property of their citizens.

#### **VI. CONTINUITY OF GOVERNMENT**

Tribes will take such measures as they deem necessary to ensure the continuance of their internal governmental structure. Any difficulties in locating or communicating with tribal authorities will be handled by the GOIA.

## **VII. ADMINISTRATION AND LOGISTICS**

Administration and logistics will be worked out between parishes and tribes on the basis of mutual aid agreements.

## **VIII. DEVELOPMENT AND MAINTENANCE**

This attachment will be updated and added to by GOHSEP as more detailed plans, procedures, arrangements and agreements are developed. The GOIA is responsible for developing and updating such components.

## **IX. AUTHORITIES AND REFERENCES**

Authorities and references are contained in the Basic Plan.

ATTACHMENT 5  
RESOURCE REQUEST FLOW CHART

# The Emergency Management Process

LEGEND	
	State Feedback
	Request for Support

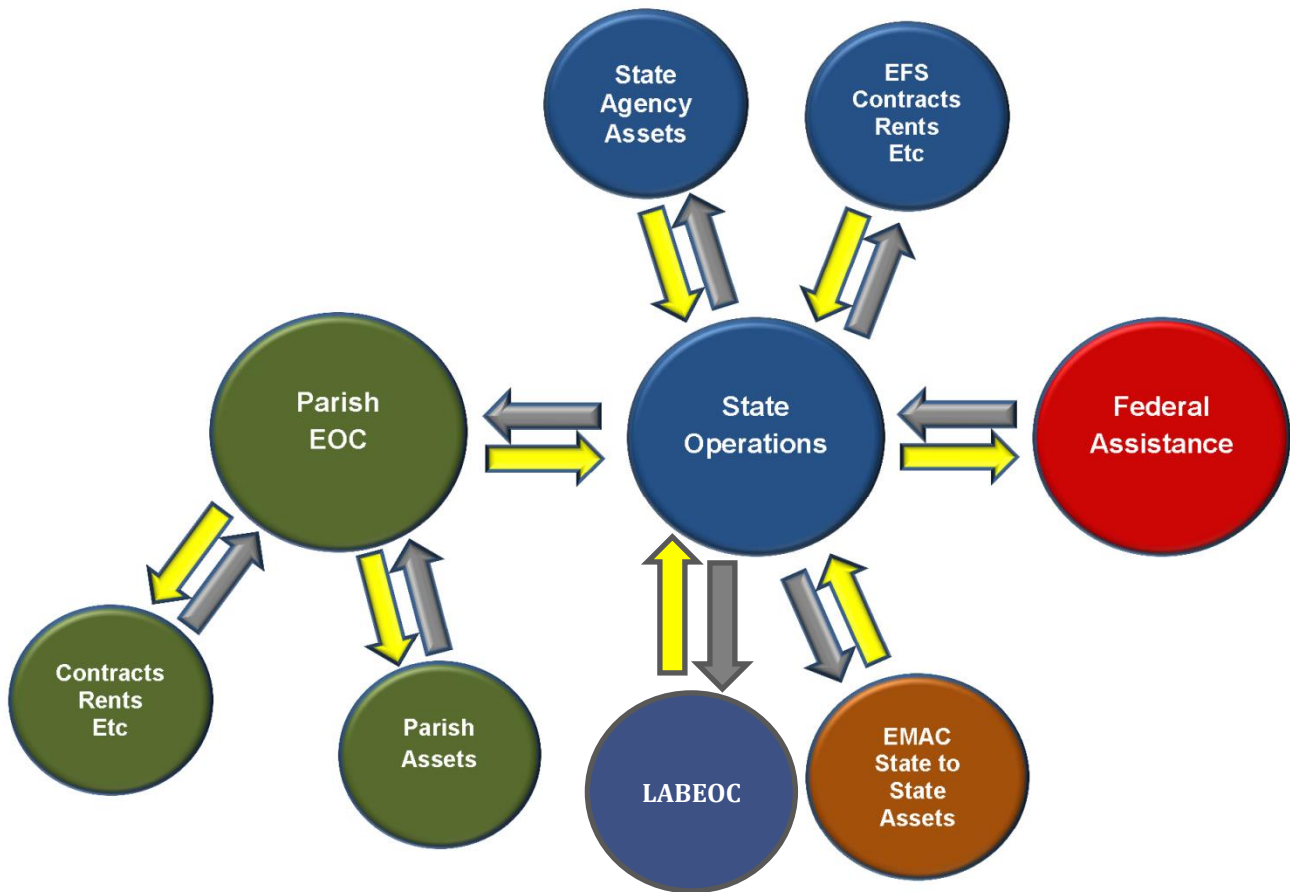

**ATTACHMENT 5A  
OPERATIONS RESOURCE REQUEST FLOW CHART  
PARISH LEVEL**

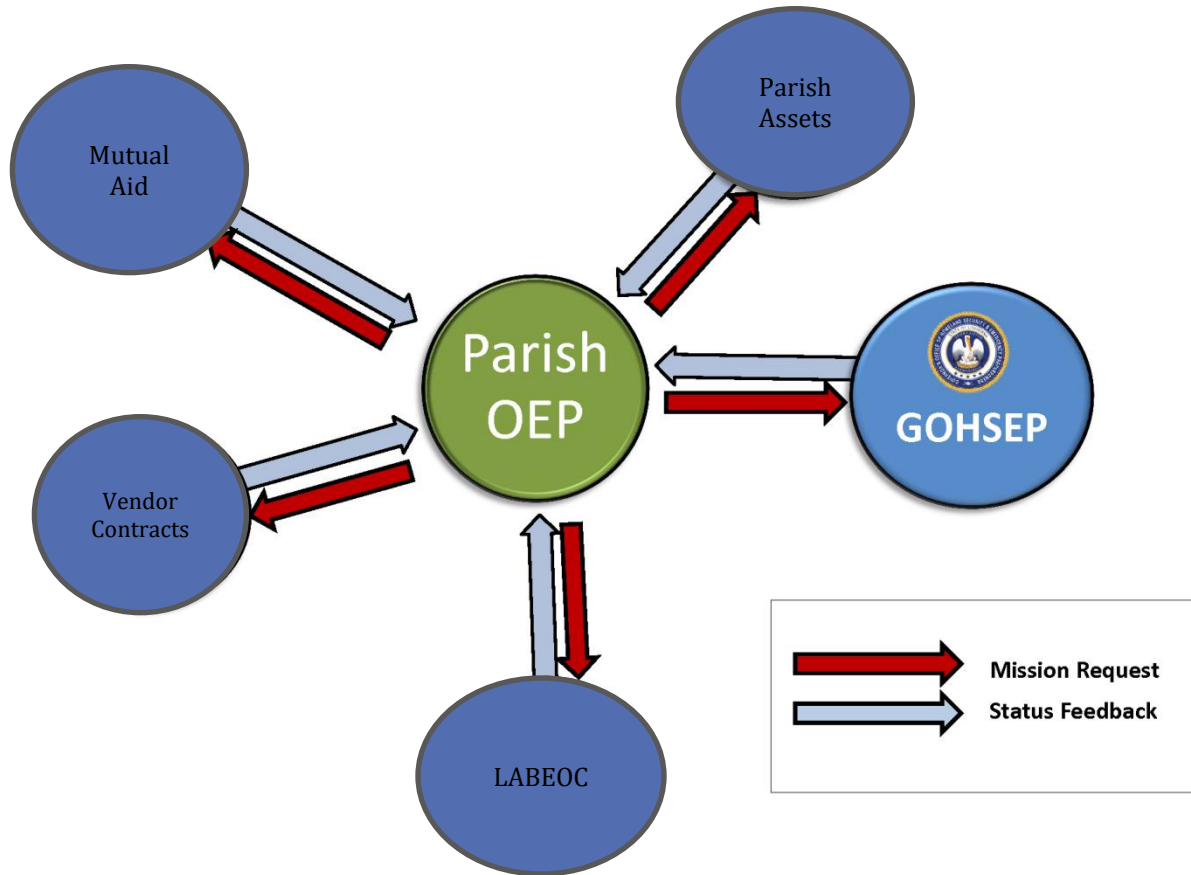

**ATTACHMENT 5B  
OPERATIONS RESOURCE REQUEST FLOW CHART  
STATE LEVEL**

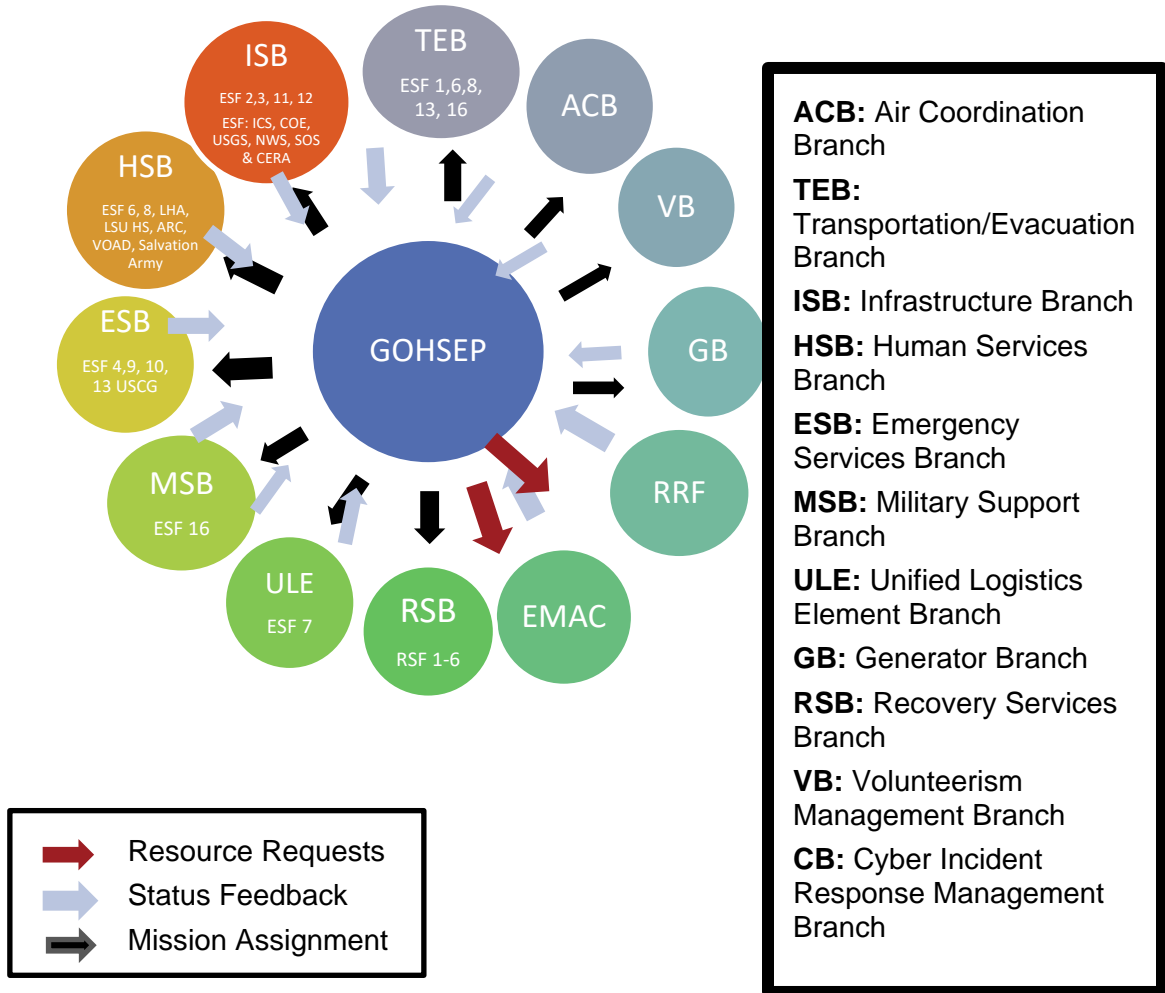

## ATTACHMENT 5C-EMERGENCY RESPONSE CHART

# UNIFIED COMMAND GROUP

Unified Commander (*Governor*)  
Deputy Unified Commander (*GOHSEP Director*)

Unified Command Staff - GOHSEP  
ESF-2, 5, 7, 15 (*JIC*),  
ESF-14 (*State of Louisiana Disaster  
Recovery Framework*)

Legislative  
Liaison

	Lead Agency Secretaries	Emergency Support Function Recover Support Function
	Secretary of Transportation & Development	ESF-1 & 3    RSF-5
	Superintendent of State Police	ESF-2, 10, 13
	The Adjutant General	ESF-2, 7, 16, 17
	Commissioner of Agriculture & Forestry	ESF-4 & 11
	Secretary of Children & Family Services	ESF-6    RSF-3
	Louisiana Economic Development	RSF 2
	Louisiana Department of Education	RSF-3
	State Fire Marshal	ESF-4
	Secretary of Louisiana Department of Health	ESF-8, 12, RSF-3
	Secretary of Wildlife & Fisheries	ESF-9, RSF-6
	Secretary of Environmental Quality	ESF-10
	Secretary of Natural Resources	ESF-12
	Public Service Commission	ESF-12
	The Attorney General	ESF-13
	Director of Workforce Commission	ESF- 6
	Director of Coastal Activities	ESF- 3    RSF 5, 6
	Division of Administration	ESF 17, RSF 1
	Coordinator of the Louisiana Oil Spill Office	ESF 10

**ATTACHMENT 5D  
UNIFIED COMMAND GROUP CHART**

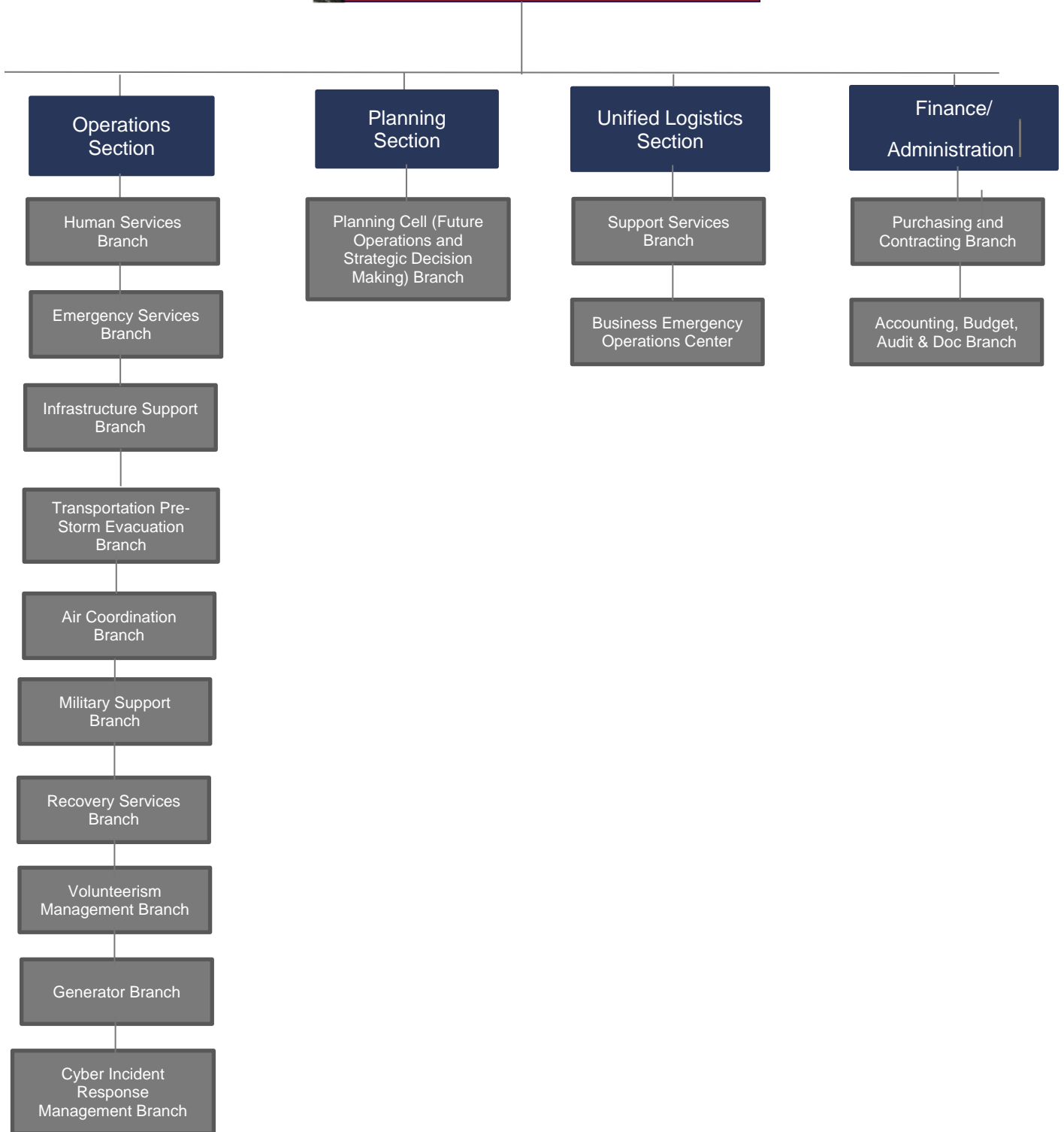

## **EMERGENCY SUPPORT FUNCTION 1 TRANSPORTATION ANNEX**

### **I. PURPOSE**

ESF 1 provides transportation out of a disaster area for people in need, and provides transportation essential to support emergency response in the event of a disaster.

### **II. SCOPE**

The State services provided under this ESF will include the identification, mobilization, and coordination of available state owned and private industry transportation, manpower and technical expertise to meet the requirements of providing essential emergency response in the event of an emergency or disaster.

### **III. CONCEPT OF OPERATIONS**

#### **A. MITIGATION:**

The Secretary of the Department of Transportation and Development will designate an ESF 1 Emergency Transportation Coordinator (ETC) to organize and coordinate transportation services.

#### **B. PREPAREDNESS:**

1. The coordinator will develop plans and procedures to mobilize transportation to support emergency evacuation for at risk populations and to support other operations of State Agencies. Plans will include coordination with the Louisiana State Police on the lifting of laws and regulations regarding load limits and other hindrances to rapid deployment.
2. The coordinator will maintain information about transportation resources, with particular emphasis on resources in or near state risk areas.

#### **C. RESPONSE:**

1. The coordinator will process requests for transportation and arrange for state agency and private industry resources to be allocated to the highest priority missions.
2. The coordinator will continue to acquire, allocate and monitor transportation resources as the emergency continues.

#### **D. RECOVERY:**

When the emergency is concluded, the ESF 1 Transportation Coordinator will release transportation assets to their responsible owners and compile an after action report on the operation.

### **IV. ORGANIZATION AND RESPONSIBILITIES**

- A. The Department of Transportation and Development has the primary responsibility for emergency transportation. That responsibility includes coordinating with support agencies to make sure that they develop and maintain plans and procedures.



B. The support agencies for emergency transportation are responsible for developing and maintaining plans, procedures and asset inventories to support the ESF 1 Coordinator. Support agencies include, but are not limited to:

1. Louisiana National Guard
2. Department of Agriculture and Forestry
3. Department of Corrections
4. Department of Education
5. Louisiana Department of Health
6. Louisiana State Police
7. Department of Wildlife and Fisheries
8. Department of Children and Family Services
9. Non-Governmental Organizations (NGO)

C. In a catastrophic event, some support agencies would contribute little or no support because they would be overwhelmed carrying out their primary responsibilities.

#### **V. COMMAND AND CONTROL**

Command and control will be exercised as provided in the basic plan

#### **VI. CONTINUITY OF GOVERNMENT**

Continuity of government will be as provided in the basic plan

#### **VII. ADMINISTRATION AND LOGISTICS**

A. If transportation needs exceed available resources, the ESF 1 Coordinator will report the situation to the Governor's Office of Homeland Security and Emergency Preparedness (GOHSEP), which will seek additional resources from EMAC and from the federal government pursuant to a Presidential Disaster Declaration.

B. Every agency providing emergency transportation support will maintain records of the operations, including cost records that can be used after the emergency to obtain reimbursement from state or federal sources.

#### **VIII. PLAN MAINTENANCE**

This ESF 1 Emergency Transportation Coordinator is responsible for developing, maintaining and coordinating plans, procedures, arrangements and agreements in support of this ESF.

#### **IX. AUTHORITIES AND REFERENCES**

Authorities and references are included in the Basic Plan.

#### **X. APPENDICES**

- A. ESF 1 Responsibility Chart
- B. State/Federal Crosswalk

**APPENDIX 1 – ESF 1  
TRANSPORTATION RESPONSIBILITY CHART**

<b>Agency support to Louisiana Department of Transportation and Development</b>	<b>Transportation Air</b>	<b>Transportation Land</b>	<b>Transportation Operators</b>	<b>Traffic Control and Routing</b>	<b>Mobile Communications</b>	<b>Fuel Supply</b>	<b>Other Coordination</b>
Louisiana National Guard	X	X	X	X			
Department of Agriculture and Forestry						X	X
Department of Corrections		X					
Department of Education		X					
Louisiana Department of Health		X					
Louisiana State Police				X	X		
Department of Wildlife and Fisheries			X				
Department of Children and Family Services							X
Non-Governmental Organizations							X
<b>To include private relief organizations (i.e. American Red Cross, Salvation Army, Mennonite Disaster Service, etc.); private industry; professional associations and participants in mutual aid agreements, etc. ( Pet transportation included for LDAF)</b>							

APPENDIX 2 – ESF 1  
TRANSPORTATION STATE – FEDERAL CROSSWALK

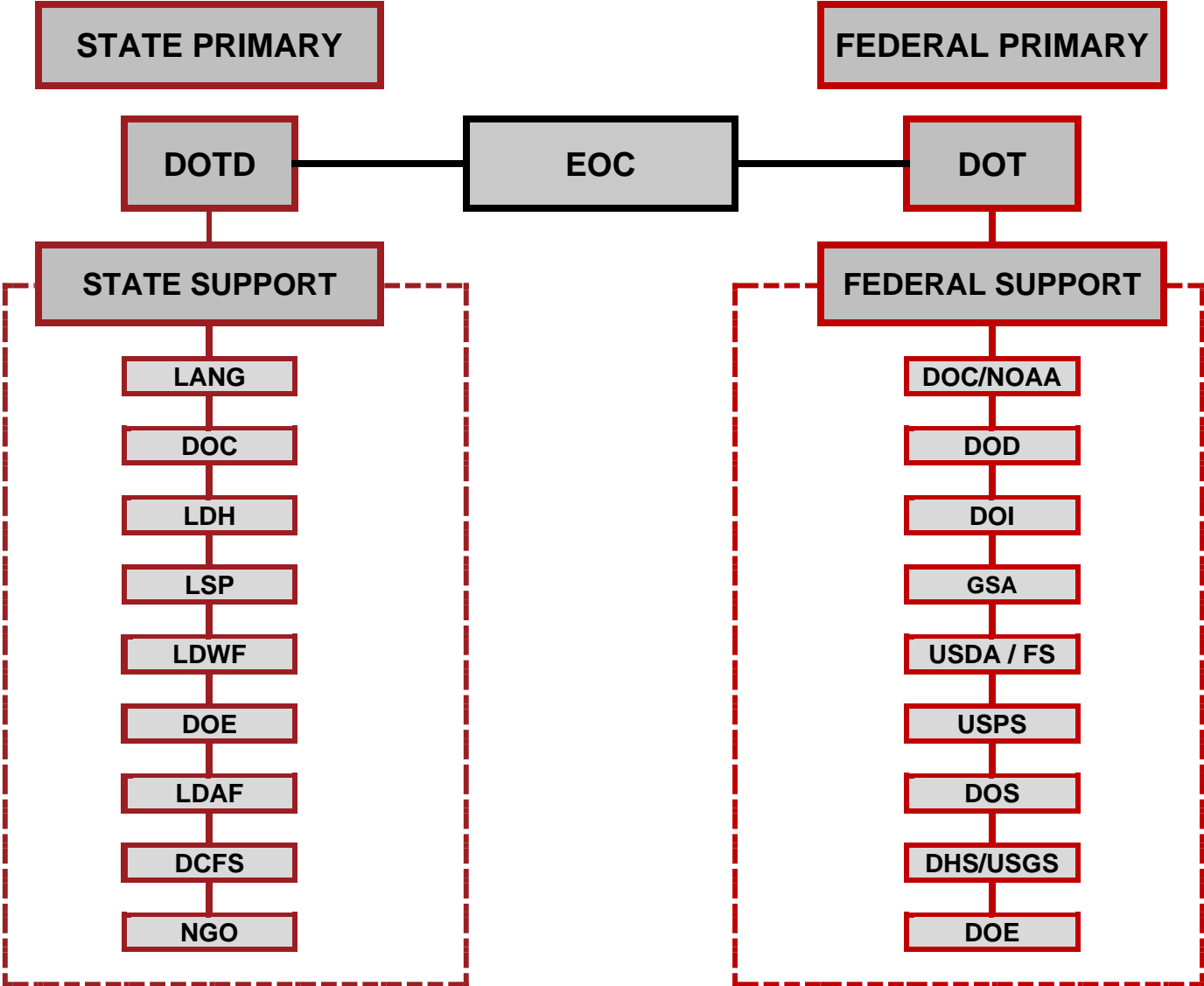

## **EMERGENCY SUPPORT FUNCTION 2 COMMUNICATIONS ANNEX**

### **I. PURPOSE**

ESF 2 provides a means of defining, specifying and maintaining the functions of communications and information technology in, with and among appropriate state, federal, and local agencies to minimize loss of life and property in the event of an emergency or natural disaster.

### **II. SCOPE**

State services under this ESF consist of the identification, mobilization and coordination of available state owned, private industry and volunteer personnel and equipment essential to gather, coordinate and disseminate information before, during and after an impending or actual disaster situation. The Louisiana Wireless Information Network (LWIN) statewide radio system has become a key element of the ESF-2 plan. In the event that normal means of communications become overburdened or destroyed, communications and information processing personnel shall use LWIN, private industry, amateur radio teams and federal assistance while primary communication systems are being re-established.

### **III. CONCEPT OF OPERATIONS**

#### **A. MITIGATION:**

The director of GOHSEP, Louisiana National Guard and the Louisiana State Police will designate ESF 2 Emergency Communications Coordinators to organize and coordinate communications.

#### **B. PREPAREDNESS:**

1. The coordinators will develop plans and procedures to mobilize communications to support emergency operations of state agencies. Plans will include coordination with the Division of Administration's Office of Technology Services and Louisiana State Police Radio Communications, as well as other federal, state and local agencies. The coordinators will provide planning and technical assistance to state and local officials and organizations
2. The coordinators will maintain the statewide communications and warning network which integrates the equipment and resources of state and local warning networks. The coordinator will initiate agreements and contracts to ensure equipment and system maintenance during times of emergency on a 24 hour basis.
3. The coordinators will provide training for communications personnel and periodically test the communications and warning systems, including alternate communications systems.

#### **C. RESPONSE:**

1. In the event of an imminent or actual disaster, the coordinators will activate the statewide communications, and warning network. Every effort will be made to support local equipment and personnel needs when requested and to integrate local resources, when appropriate, to a regional or statewide response.
2. The state will operate and maintain necessary equipment in the State Emergency Operations Center (EOC) to provide 24 hour-a-day, 7 day-a-week operational communications capability on appropriate government radio networks. Mobile equipment will be provided by ESF 2 lead

agencies to GOHSEP staff personnel having on-the-scene or coordinating responsibilities. The Louisiana State Police Radio Communications Section will coordinate the maintenance and deployment of mobile tower sites, generators, and backhaul satellite assets for the LWIN system as directed by ESF-2.

3. Advisories will be made throughout state and local communications networks as appropriate to alert local governments to conditions. GOHSEP will use the Integrated Public Alert and Warning System (IPAWS) which includes the Emergency Alert System (EAS) and Wireless Emergency Alerts (WEA). As the imminent threat of disaster warrants, warning systems will be employed until stable conditions return.
4. GOHSEP will maintain contact with FEMA Region VI, other states, and parish emergency management agencies and major cities.

#### D. RECOVERY:

The communications coordinators will canvas state, federal and local communicators to ensure that all communications and information processing media have been restored to normal operations. The coordinators will see to it that all leased and borrowed personnel and equipment are returned to the owners.

The coordinators will compile an after-action report on the operation, with recommendations for future operations.

### IV. ORGANIZATION AND RESPONSIBILITIES

- A. GOHSEP, Louisiana National Guard (LANG) and Louisiana State Police (LSP) have primary responsibility for initiating, organizing, and coordinating all aspects of Communications.
- B. The Support Agencies for ESF 2 are responsible for developing and maintaining plans, procedures, and asset inventories to support the primary coordinator. Support agencies include, but are not limited to:
  1. Division of Administration
  2. Department of Agriculture and Forestry
  3. Department of Corrections
  4. Department of Culture, Recreation & Tourism
  5. Department of Economic Development
  6. Department of Education
  7. Department of Environmental Quality
  8. Louisiana State Police
  9. Office of Elderly Affairs
  10. Office of the Lieutenant Governor
  11. Louisiana Oil Spill Coordinators Office
  12. Louisiana State University System
  13. Louisiana Department of Health
  14. Department of Justice

15. Louisiana Workforce Commission
16. Louisiana Public Service Commission
17. Louisiana Board of Regents
18. Department of Revenue
19. Department of Children and Family Services
20. Department of Transportation & Development
21. Department of Wildlife and Fisheries
22. Non-Governmental Organizations (NGO)

**V. COMMAND AND CONTROL**

Command and control will be exercised as provided in the basic plan

**VI. CONTINUITY OF GOVERNMENT**

Continuity of government will be as provided in the basic plan

**VII. ADMINISTRATION, INTEROPERABILITY AND LOGISTICS**

The ESF 2 coordinators with LSP Radio Communications will initiate and maintain predefined and event interoperability plans between responder tiers on the Interoperable Statewide Network

**VIII. PLAN MAINTENANCE**

The ESF 2 Coordinators are responsible for developing, maintaining and coordinating plans, procedures, arrangements, and agreements in support of this ESF.

**IX. AUTHORITIES AND REFERENCES**

Authorities and references are included in the Basic Plan

**X. APPENDICES:**

- A. ESF 2 Responsibility Chart
- B. State – Federal Crosswalk

**APPENDIX 1 – ESF 2  
COMMUNICATIONS RESPONSIBILITY CHART**

<b>Agency support to the Governor’s Office of Homeland Security and Emergency Preparedness, Louisiana State Police and Louisiana National Guard</b>	<b>Authority / Policy</b>	<b>Coordination</b>	<b>EOC Operations</b>	<b>Analysis</b>	<b>Personnel</b>	<b>Fixed Sites</b>	<b>Mobile Sites</b>
Department of Agriculture and Forestry		X	X	X	X	X	X
Department of Corrections		X	X	X	X	X	X
Department of Culture, Recreations & Tourism			X	X	X	X	X
Department of Economic Development			X	X	X		
Department of Education			X	X	X		
Department of Environmental Quality			X	X	X		
Division of Administration	X	X	X	X	X		
Office of Elderly Affairs	X	X					
Office of the Lieutenant Governor			X	X	X	X	X
Louisiana Oil Spill Coordinators Office			X	X	X		
Louisiana State University System			X	X	X		
Louisiana Department of Health			X	X	X		
Department of Justice			X	X	X		
Louisiana Workforce Commission			X	X	X		
Louisiana Public Service Commission	X	X	X	X	X		
Louisiana Board Of Regents		X	X	X	X	X	
Department of Revenue			X	X	X		
Department of Children and Family Services			X	X	X		
Department of Transportation & Development			X	X	X	X	X
Department of Wildlife and Fisheries			X	X	X	X	X
Non-Governmental Organizations (NGO) *			X		X	X	X

**\* To include private relief organizations (i.e. American Red Cross, Salvation Army, Mennonite Disaster Service, etc.); private industry; professional associations and participants in mutual aid agreements, etc.**

**APPENDIX 2 – ESF 2  
COMMUNICATIONS STATE – FEDERAL CROSSWALK**

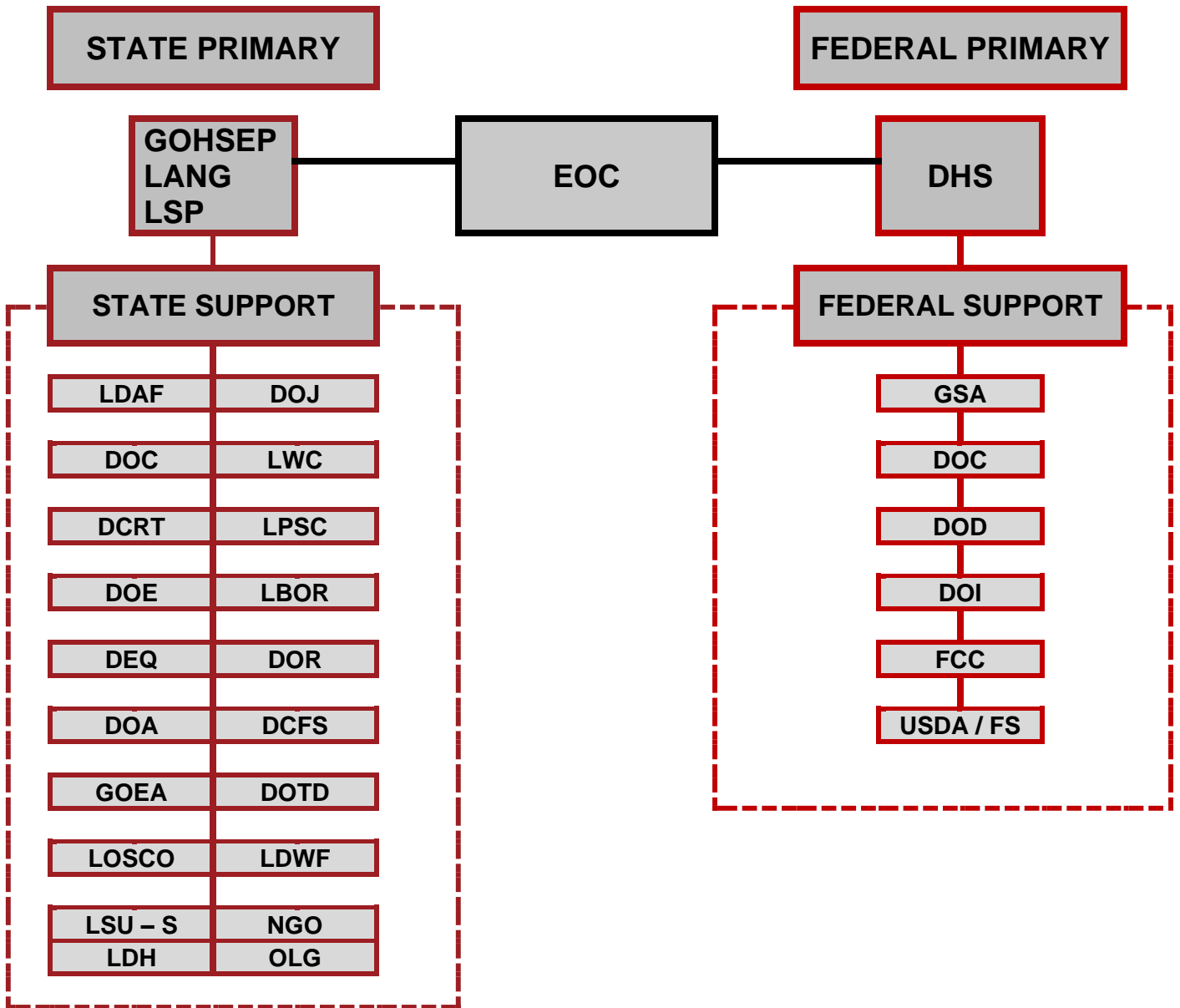



**EMERGENCY SUPPORT FUNCTION 3  
PUBLIC WORKS AND ENGINEERING ANNEX**

**I. PURPOSE**

ESF 3 provides for and coordinates all available engineering and construction resources and expertise in an emergency or disaster.

**II. SCOPE**

The state assistance provided under this function will include the identification of critical infrastructure and topographic problems, shortcomings and damages, and the mobilization and coordination of state owned and private industry resources to fix and improve them. The Department of Transportation and Development (DOTD) and The Coastal Protection and Restoration Authority (CPRA) will have primary responsibility for this ESF.

- A. ESF 3 will include the development, maintenance and repair of hurricane and flood evacuation routes and their associated state highways and bridges; provide administrative function assistance to entities responsible for construction, maintenance and repair of state flood control works; provide administrative function assistance to the Office of the Governor – Division of Administration – Facility Planning and Control and any other entities responsible for coordination of technical expertise regarding the structural safety of damaged state buildings and coordination of emergency repairs to state owned facilities, including appropriate construction services (i.e., electrical, plumbing, soils, etc.).
- B. Where needed and feasible, ESF 3 will coordinate removal of debris and wreckage accumulated on state owned lands, waterways, roadways and bridges as a result of a disaster.
- C. Where needed and feasible, ESF 3 will coordinate emergency removal of ice and snow.
- D. ESF 3 will coordinate the dewatering, unwatering, and other protective measures to protect lives and property and reduce the effects of high water on the state's infrastructure.
- E. CPRA ESF 3 will coordinate the evaluation of the degree of coastal and watershed erosion and impairment and take action to coordinate the repair and restoration of the affected areas.

**III. CONCEPT OF OPERATIONS**

**A. MITIGATION:**

The Secretary of the Department of Transportation and the Director of the Coastal Protection and Restoration Authority will appoint ESF 3 Coordinators, who will oversee all activities in this category. The ESF 3 Coordinators will formulate and coordinate plans for the construction of works for the prevention and mitigation of future damages from emergencies and disasters.

## B. PREPAREDNESS:

1. The ESF 3 Coordinators will develop plans, procedures, arrangements and agreements to allow the activities required by ESF 3 to be carried out effectively and efficiently.
2. The ESF 3 Coordinators will initiate contacts with other state/federal agencies and organizations, in particular, the Department of Natural Resources (DNR) and the United States Department of Agriculture – Natural Resources Conservation Service (USDA – NRCS), the U.S. Army Corps of Engineers (USACE), Levee Boards and the Federal Highway Administration (FHWA) to facilitate cooperation in emergencies and disasters.
3. ESF 3 Coordinators will work with emergency organizations such as the Governor's Office of Homeland Security and Emergency Preparedness (GOHSEP) and regional emergency task forces to confirm that the state's infrastructure is adequate to support traffic flows in large scale evacuations. Particular attention will be paid to hurricane evacuation routes in the southern part of the state.
4. ESF 3, when requested, will coordinate with entities responsible for designing, constructing and maintaining levees and flood control structures and provide administrative function assistance to these entities as specified in La. R.S. 38:2, et seq.

## C. RESPONSE:

1. When an emergency is imminent, the ESF 3 Coordinators will assess the potential impact of the threat on the state's infrastructure and work with other authorities to confirm that any necessary immediate repairs or arrangements for critical state structures and facilities are initiated.
2. The ESF 3 Coordinators will work with all state and local authorities to support the evacuation of people in the threatened area(s).
3. As the emergency progresses, the coordinators will monitor the status of the infrastructure and effect emergency repairs where needed and feasible.
4. The ESF 3 Coordinators will monitor the status of debris on critical state evacuation routes and initiate emergency debris clearance and repairs to save lives where needed and feasible.
5. The ESF 3 Coordinators will conduct coordination with the ACOE and US Coast Guard to initiate emergency debris clearance where needed and feasible.

## D. RECOVERY:

1. When an emergency has passed, the ESF 3 Coordinators will assess damages to critical state infrastructure and initiate debris clearance and repairs.
2. The CPRA ESF 3 Coordinators will coordinate the assessment of damages to coastal zones and watersheds and coordinate the planning and accomplishment of restoration work.
3. The ESF 3 Coordinators will use the information on disaster damage to formulate plans for structures and measures to prevent and mitigate damages from future emergencies and disasters.

#### **IV. ORGANIZATION AND RESPONSIBILITIES**

- A. The Department of Transportation and Development and the Coastal Protection and Restoration Authority have primary responsibility for obtaining, organizing and coordinating Public Works and Engineering.
- B. The support agencies for Public Works and Engineering are responsible for developing and maintaining plans, procedures and asset inventories to support the primary coordinators. Support agencies include, but are not limited to:
  - 1. Division of Administration
  - 2. Louisiana Department of Health
  - 3. Department of Natural Resources
  - 4. Department of Environmental Quality
  - 5. Louisiana National Guard
  - 6. Non-Governmental Organizations (NGO)

#### **V. COMMAND AND CONTROL**

Command and Control will be exercised as provided in the Basic Plan

#### **VI. CONTINUITY OF GOVERNMENT**

Continuity of government will be as provided in the Basic Plan

#### **VII. ADMINISTRATION AND LOGISTICS**

- A. If local, parish and state resources are inadequate to accomplish the tasks assigned, the ESF 3 Coordinators will advise GOHSEP to seek additional resources from EMAC and from the federal government pursuant to a Presidential Disaster Declaration.
- B. Every agency providing resource support services will maintain records of the operations, including cost records that can be used after the emergency to obtain reimbursement from state or federal resources.

#### **VIII. PLAN MAINTENANCE**

The ESF 3 Coordinators are responsible for developing, maintaining and coordinating plans, procedures, arrangements, and agreements in support of this ESF.

#### **IX. AUTHORITIES AND REFERENCES**

Authorities and references are included in the Basic Plan

#### **X. APPENDICES**

- A. ESF 3 Responsibility Chart
- B. State–Federal Crosswalk

**C. APPENDIX 1 – ESF 3  
PUBLIC WORKS AND ENGINEERING RESPONSIBILITY CHART**

<b>Agency support to Louisiana Department of Transportation and Development and Coastal Protection and Restoration Authority</b>	<b>Engineering Personnel and Equipment</b>	<b>Debris Removal</b>	<b>Debris Disposal</b>	<b>Coastal Restoration</b>	<b>Watershed Protection</b>
Division of Administration	X	X	X		
Louisiana Department of Health			X		
Department of Natural Resources			X	X	X
Department of Environmental Quality		X	X		
Louisiana National Guard	X	X			X
Non-Governmental Organizations		X	X	X	
<p><b>*To include private relief organizations (i.e. American Red Cross, Salvation Army, Mennonite Disaster Service, etc.); private industry; professional associations and participants in mutual aid agreements, etc.</b></p>					

**APPENDIX 2 – ESF 3  
PUBLIC WORKS AND ENGINEERING STATE – FEDERAL CROSSWALK**

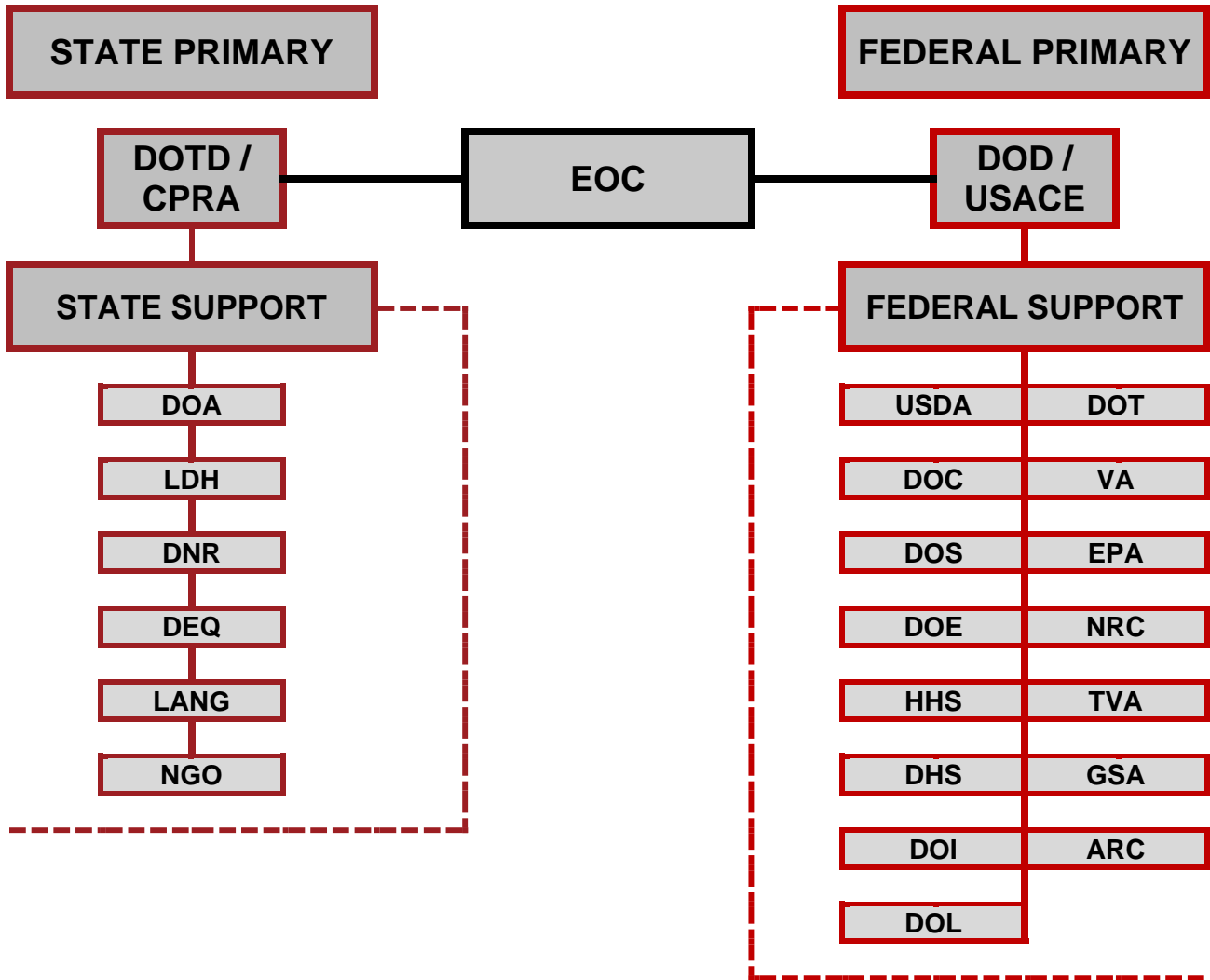

## **EMERGENCY SUPPORT FUNCTION 4 FIREFIGHTING ANNEX**

### **I. PURPOSE**

The potential for damage from fires in urban areas during and after a major disaster is extremely high. Fires have the potential to spread rapidly causing extensive damage and threatening life and property. Normally available firefighting resources may be difficult to obtain and utilize because of massive disruptions of communications, transportation, utility and water systems and other challenges caused by the event. ESF 4 provides for the detection, control, and suppression of rural and urban fires, caused by or incident to natural or technological events

### **II. SCOPE**

State services provided under this ESF shall include actions taken through the application of equipment, manpower, and technical expertise to control and suppress fires that have or threaten to become disasters. Provision of such services will be in accordance with mutual aid compact agreements with local governments, private industry, other states, the federal government and established recognized standards of firefighting methods.

### **III. CONCEPT OF OPERATIONS**

The Commissioner of Agriculture & Forestry and the State Fire Marshal are responsible for ESF 4, including the development, implementation and administration of all state programs, mutual aid agreements, and participation in this function as related to emergency or disaster assistance.

#### **A. MITIGATION:**

The Commissioner of Agriculture & Forestry and the State Fire Marshal will designate an ESF Coordinator to organize and coordinate all state involvement in emergency fire services.

#### **B. PREPAREDNESS:**

1. The ESF 4 Coordinator will develop plans, procedures and agreements with state, federal and local departments, agencies and groups.
2. The coordinator will work with state, federal and local departments, agencies and groups to ensure that their people and resources are trained and exercised periodically.
3. The coordinator will monitor fire conditions throughout the state to maintain awareness of threats.

#### **C. RESPONSE:**

1. When a fire becomes extensive and cumbersome for local and parish authorities to control and a State of Emergency is declared, the Parish Emergency Manager will request for assistance from GOHSEP initially and the ESF 4 Coordinator will mobilize state mutual aid and private industry and volunteer resources to assist in fighting and suppressing the fire. Additional resources will operate according to the Incident Command System.
2. If available state and private industry and volunteer resources are inadequate to contain and suppress the fire the coordinator will call on resources from other states and the federal government through existing mutual aid agreements or EMAC.

#### **D. RECOVERY:**

After the fire is contained and suppressed state, private industry, volunteer and federal resources will be withdrawn as soon as feasible and after-action reports will be compiled and consolidated. Any lesson learned from the action will be used to develop mitigation measures. The State Fire Marshal, shall, upon the request of the local emergency operation coordinator or local governing authority, provide inspection services to ensure all structures, including one-and two family dwellings, are free from the threat of fire and are structurally safe to reoccupy.

#### **IV. ORGANIZATION AND RESPONSIBILITIES**

- A. The Louisiana Department of Agriculture and Forestry and the State Fire Marshal have co-primary responsibility for firefighting. That responsibility includes the coordination with support agencies to make sure that they develop and maintain plans and procedures.
- B. The support agencies for firefighting are responsible for developing and maintaining plans, procedures and asset inventories to support the ESF 4 Coordinator. Support agencies include, but are not limited to:
  - 1. Louisiana National Guard
  - 2. Department of Environmental Quality
  - 3. Department of Transportation and Development
  - 4. Department of Wildlife and Fisheries
  - 5. Non-Governmental Organizations (NGO)

#### **V. COMMAND AND CONTROL**

Command and control will be exercised as provided in the Basic Plan. The Incident Command System will be used.

#### **VI. CONTINUITY OF GOVERNMENT**

Continuity will be as provided in the Basic Plan

#### **VII. ADMINISTRATION AND LOGISTICS**

The ESF 4 Coordinator will pursue mutual aid agreements through EMAC and other agreements

Every agency providing firefighting support and resources will maintain records of their operations, including cost records that can be used after the emergency to obtain reimbursement from state or federal sources.

#### **VIII. PLAN MAINTENANCE:**

The ESF 4 Coordinator will develop, maintain and coordinate plans, procedures, arrangements and agreements in support of this ESF.

**IX. AUTHORITIES AND REFERENCES:**

Authorities and references are included in the Basic Plan

**X. APPENDICES:**

A. ESF 4 Responsibility Chart

B. State-Federal Crosswalk



**APPENDIX 1 – ESF 4  
FIREFIGHTING RESPONSIBILITY CHART**

Agency support to Louisiana Department of Agriculture and Forestry and State Fire Marshal	Fire Fighting Equipment and Personnel	Petroleum & Fuels Service	Training and Technical Assistance	Transportation – Air	Transportation – Water	Transportation – Land
Louisiana National Guard	X		X	X		X
Department of Environmental Quality			X			
Department of Transportation & Development		X	X			X
Department of Wildlife and Fisheries	X			X	X	X
Non-Governmental Organizations (NGO) *	X		X	X		X
* To include private relief organizations (i.e. American Red Cross, Salvation Army, Mennonite Disaster Service, etc.); private industry; professional associations and participants in mutual aid agreements, etc.						

APPENDIX 2 – ESF 4  
FIREFIGHTING STATE – FEDERAL CROSSWALK

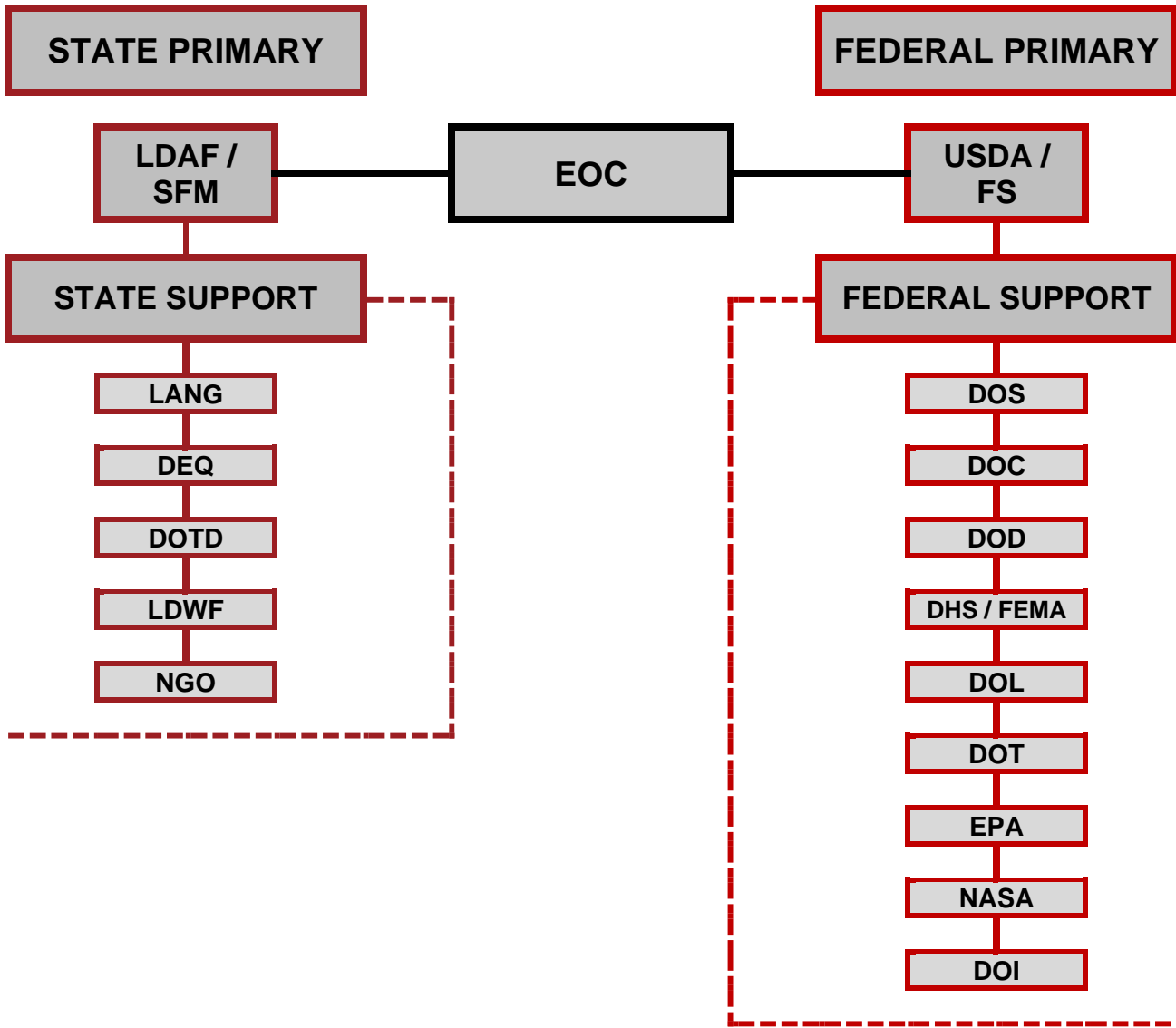

## **EMERGENCY SUPPORT FUNCTION 5 EMERGENCY MANAGEMENT ANNEX**

### **I. PURPOSE**

ESF 5 Emergency Management provides for operational direction, control and management of state, local and parish activities and resources available for or committed to emergency or disaster operations.

### **II. SCOPE**

ESF 5 Emergency Management encompasses all emergency activities conducted by state, local and parish governments, private industry and Non-Governmental Organizations (NGO) before, during and after natural and technological emergencies and disasters. The ESF includes planning and preparations before emergencies, collecting, communicating and analyzing information about impending and impacting emergencies, assessing the impact and damages from emergencies, setting all available resources into motion and restoring the affected people and property to their pre-disaster condition, wherever possible.

### **III. CONCEPT OF OPERATIONS**

GOHSEP director has primary responsibility for the Emergency Management ESF. Actions will be carried out in accordance with policy guidance controlling the use of state resources (personnel, physical, fiscal) established by the governor.

#### **A. MITIGATION:**

The director of GOHSEP will designate an ESF 5 Emergency Management Coordinator to organize and administer the ESF.

#### **B. PREPAREDNESS:**

1. The ESF 5 Coordinator will develop plans, procedures, arrangements and agreements to identify, acquire and mobilize all the resources in and of the state in pursuit of raising the preparedness of the state.
2. The ESF 5 Coordinator will develop and maintain information and liaison with agencies and organizations at local, parish, state and federal government, private industry and Non-Governmental Organizations (NGO) that could furnish assistance in an emergency or disaster.
3. The ESF 5 Coordinator will build, equip, organize and maintain the Emergency Operations Center as a control and coordination facility for state departments and agencies, private industry and volunteer groups to come to work together to deal with the potential and actual consequences of emergencies and disasters.

#### **C. RESPONSE:**

1. As an emergency threatens, the ESF 5 Operations Coordinator will assess the threat, potential needs and alert and mobilize appropriate state agencies, private industry and Non-Governmental Organizations (NGO) whose capabilities would best be suited to responding to the emergency.

2. As an emergency threatens, the ESF 5 Operations Coordinator will establish and monitor information gathering and reporting activities to get the best possible information on the situation.
3. If an emergency generates needs that grow beyond local, parish and state government, private industry and Non-Governmental Organizations (NGO)' resources, the ESF-5 Operations Coordinator will procure needed resources via the Federal Emergency Management Agency (FEMA) or from other states through the Emergency Management Assistance Compact (LRS 29:733 Emergency Preparedness and Disaster Compact).
4. The Operational Period Common Operating Picture (COP) analysis and Situational Report (SITREP) will be facilitated by the Emergency Management Planning Cell. The Emergency Management Planning Cell supplements the ESF-5 Operational Coordinator in order to provide a big picture vision, ensure planning best practices are achieved, and to streamline and coordinate necessary tactical strategies with leadership, support, and coordination as necessary from appropriate state agency and NGO resources.

#### D. RECOVERY:

1. Emergency Management response activities will continue as long as they are needed. The coordinator will continue to monitor resource needs to determine when activities can be turned to recovery.
2. As soon as possible after the emergency has passed, all agencies involved in the emergency will conduct damage assessment activities. Damage assessments will be used to define the need for resources and strategies needed for recovery. The Disaster Recovery Manual will be used to guide all damage assessment, analysis, documentation and reporting of damages.
3. The ESF-5 Coordinator will work with local, parish, state, and federal government agencies, private industry, and Non-Governmental Organizations (NGO) to ensure that relief and restoration efforts are channeled through ESF-14 to the areas in the greatest need. The ESF 5 Planning Cell will facilitate goals, objectives, and special coordination with appropriate organizations such as NGO's and the LA Business Emergency Operations Center (BEOC), in order to facilitate restoration efforts. The ESF 5 Planning Cell will also assist in the coordination of the necessary outreach campaigns with the Public Information Officer to ensure the activation of ESF 14 will strongly support impacted communities through an extensive recovery effort.
4. The ESF 5 Coordinator will gather, collate and analyze information about the emergency or disaster and use that information to create plans and initiatives to mitigate and prevent future disasters.

#### IV. ORGANIZATION AND RESPONSIBILITIES

- A. GOHSEP has primary responsibility for initiating, organizing, and coordinating all aspects of Emergency Management.
- B. The support agencies for ESF 5 are responsible for developing and maintaining plans, procedures and asset inventories to support the primary coordinator. Support agencies include, but are not limited to:
  1. Louisiana National Guard
  2. Department of Agriculture and Forestry

3. Department of Corrections
4. Department of Culture, Recreation, & Tourism
5. Department of Economic Development
6. Department of Education
7. Department of Environmental Quality
8. Division of Administration
9. Office of Disability Affairs
10. Office of Elderly Affairs
11. Office of Indian Affairs
12. Office of the Lieutenant Governor
13. Louisiana Oil Spill Coordinators Office
14. Louisiana State University System
15. Louisiana Department of Health
16. Department of Justice
17. Louisiana Workforce Commission
18. Department of Natural Resources
19. Louisiana Public Service Commission
20. Louisiana Board of Regents
21. Department of Revenue
22. Secretary of State
23. Department of Children and Family Services
24. Louisiana State Police
25. Department of Transportation & Development
26. Department of the Treasury
27. Department of Wildlife and Fisheries
28. Louisiana Coastal Protection and Restoration Authority
29. Department of Public Safety
30. State Fire Marshal
31. Non-Governmental Organizations (NGO)

#### **V. COMMAND AND CONTROL**

Command and Control will be exercised as provided in the Basic Plan

#### **VI. CONTINUITY OF GOVERNMENT**

Continuity of government will be as provided in the Basic Plan

## **VII. ADMINISTRATION AND LOGISTICS**

- A. If local, parish and state resources are inadequate to the tasks assigned; the ESF 5 Coordinator will seek additional resources from EMAC and from the federal government pursuant to a Presidential Disaster Declaration.
- B. Every agency providing ESF 5 services will maintain records of the operations, including cost records that can be used after the emergency to obtain reimbursement from state or federal resources.

## **VIII. PLAN MAINTENANCE**

The ESF 5 Operations Section Chief is responsible for developing, maintaining and coordinating plans, procedures, arrangements and agreements in support of this ESF.

## **IX. AUTHORITIES AND REFERENCES**

Authorities and references are included in the Basic Plan

## **X. APPENDICES**

- A. ESF 5 Responsibility Chart
- B. State-Federal Crosswalk

**APPENDIX 1 – ESF 5  
EMERGENCY MANAGEMENT CHART**

<b>Agency support to the Governor’s Office of Homeland Security and Emergency Preparedness</b>	<b>Authority / Policy</b>	<b>Coordination</b>	<b>EOC Operations</b>	<b>Analysis</b>	<b>Damage Assessment</b>	<b>Damage Reporting</b>	<b>Economic Analysis</b>
Louisiana National Guard	X	X	X	X	X	X	
Department of Agriculture and Forestry			X	X	X	X	X
Department of Corrections			X	X	X	X	
Department of Culture, Recreations & Tourism			X	X	X	X	
Department of Economic Development			X	X	X	X	X
Department of Education			X	X	X	X	X
Department of Environmental Quality			X	X	X	X	
Division of Administration	X	X	X	X	X	X	X
Office of Disability Affairs			X	X			
Office of Elderly Affairs			X	X	X	X	
Office of Indian Affairs	X	X	X	X	X	X	X
Office of the Lieutenant Governor			X	X	X	X	
Louisiana Oil Spill Coordinators Office			X	X	X	X	X
Louisiana State University System			X	X	X	X	
Louisiana Department of Health			X	X	X	X	
Department of Justice	X	X	X	X	X	X	
Louisiana Workforce Commission			X	X	X	X	X
Department of Natural Resources			X	X	X	X	X
Louisiana Public Service Commission			X	X	X	X	X
Louisiana Board of Regents			X	X	X	X	X
Department of Revenue			X		X	X	X
Secretary of State	X	X	X		X		
Department of Children and Family Services			X	X	X	X	X
Louisiana State Police	X	X	X	X	X	X	
Department of Transportation & Development			X	X	X	X	
Department of Treasury	X	X	X	X	X	X	X
Department of Wildlife and Fisheries			X	X	X	X	X
Louisiana Coastal Protection and Restoration Authority		X	X	X	X	X	X
Non-Governmental Organizations (NGO) *			X		X	X	

**\* To include private relief organizations (i.e. American Red Cross, Salvation Army, Mennonite Disaster Service, etc.); private industry; professional associations and participants in mutual aid agreements, etc.**

**APPENDIX 2 – ESF 5  
EMERGENCY MANAGEMENT STATE – FEDERAL CROSSWALK**

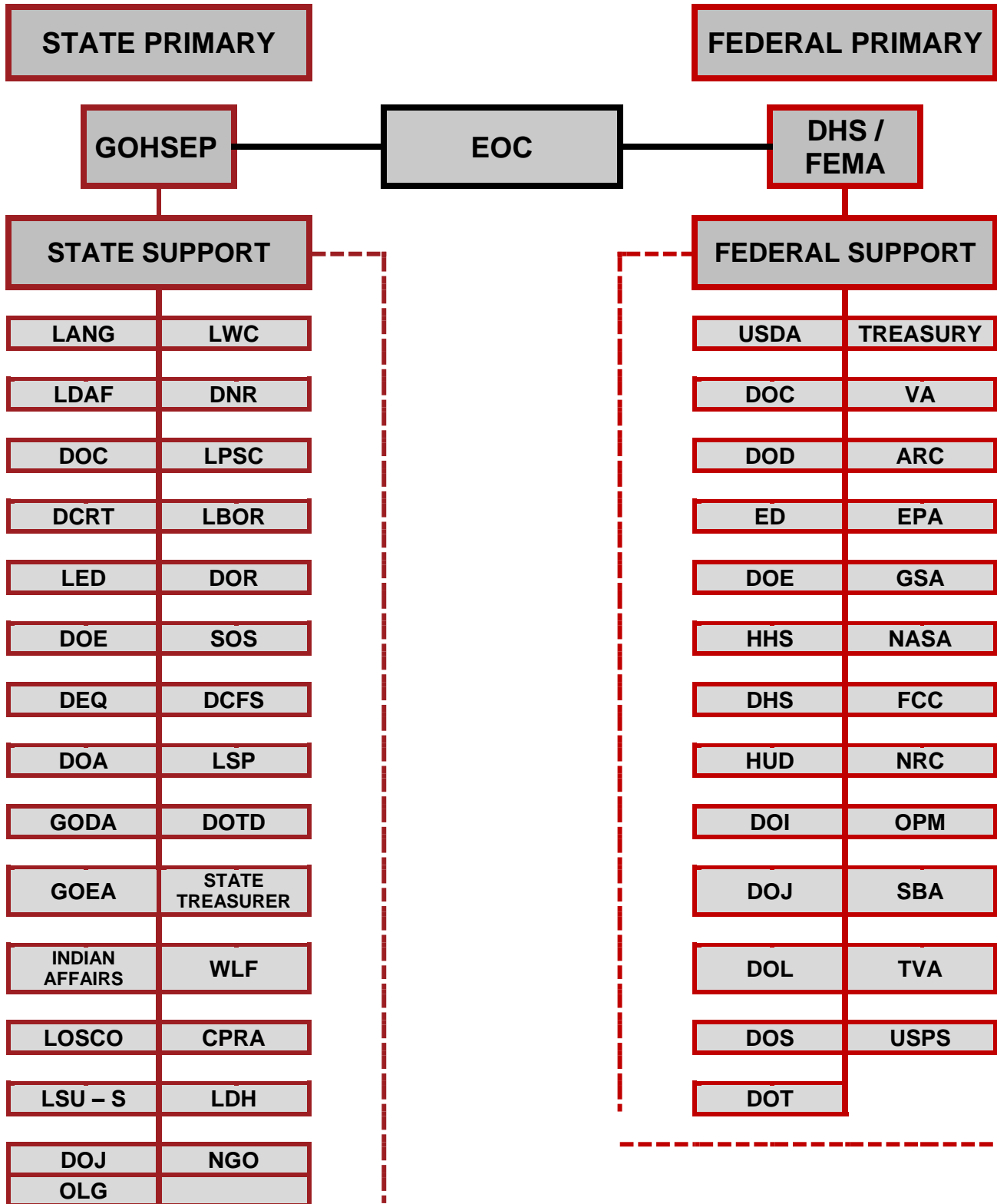



## **EMERGENCY SUPPORT FUNCTION 6 MASS CARE, HOUSING, AND HUMAN SERVICES ANNEX**

### **I. PURPOSE**

ESF-6 Provides Mass Care, Housing, and Human Services support for victims of natural and technological emergencies and disasters.

### **II. SCOPE**

State assistance provided under ESF-6 will encompass the following functions and services to promote the delivery of services and the implementation of programs to assist victims of potential and/or actual emergencies and disasters. ESF-6 will provide assistance to persons without regard to race, religion, nationality, gender, age, disability, sexual orientation or economic status.

#### **A. MASS CARE:**

1. DCFS, in conjunction with local governments, the American Red Cross (ARC) and other entities as necessary, will provide shelters prior to and immediately following an emergency or disaster, in which individuals and families are housed as a result of evacuation and/or pending repair of dwellings or movement into temporary housing. Emergency shelter is not intended for prolonged periods of occupancy due to the nature of the limited provisions available in sheltering facilities.
2. LWC will coordinate with state agencies and other entities to provide mass feeding of victims and emergency workers through a combination of fixed sites and mobile feeding units.
3. DCFS will interface with the Louisiana Department of Health (LDH) to ensure the provision of emergency first aid for victims and emergency workers at shelters and designated sites, and referral to appropriate medical facilities.
4. DCFS will collect and provide information about individuals in state run shelters affected by emergencies and disasters and require state assistance via an electronic evacuee tracking system. Such information will be used to aid in the reunification of families and individuals separated by emergencies and disasters.

#### **B. HOUSING:**

1. Housing requires the coordination of efforts to assist in meeting short- and long-term housing needs of victims utilizing emergency, extended, and transitional sheltering strategies.

#### **C. HUMAN SERVICES:**

1. DCFS and LDH, in conjunction with support agencies will provide assistance to victims of emergencies and disasters including, but not limited to, the provision of recovery counseling, case management, mental health services, food assistance programs such as Disaster Supplemental Nutritional Assistance Program (DSNAP) and assistance with identification of other support for persons with special needs.

### III. CONCEPT OF OPERATIONS

The Department of Children and Family Services (DCFS) and the Louisiana Workforce Commission (LWC) are the two primary agencies responsible for Emergency Support Function (ESF)-6. DCFS has the primary responsibility for coordinating mass care, housing and human services. LWC has the primary responsibility for coordinating mass feeding. The purpose of this plan is to describe the procedures and necessary coordination between the Governor's Office of Homeland Security and Emergency Preparedness (GOHSEP), the ESF-6 primary and supporting agencies and parish and local governments in order to address the non-medical mass care, housing and human services needs of victims of natural and technological disasters.

ESF-6 lead agencies, in cooperation with support agencies will provide trained staff to perform the state's ESF-6 functions during the preparedness, response and recovery phases of emergencies and disasters. Most incidents are generally handled by a single jurisdiction at the local level; therefore, requests for emergency assistance will be resolved at the lowest local level when feasible. Unresolved assistance requests will ascend from the local EOC level to the State EOC. There are important instances in which successful incident management operations depend on the involvement of multiple jurisdictions, functional agencies, and emergency responder disciplines. These instances require effective and efficient coordination across this broad spectrum of organizations and activities. ESF-6 will report incident situational awareness to GOHSEP. ESF-6 will track the status of outstanding pending assistance requests and establish requirements to resolve and report documented information in status reports over the life cycle of a disaster.

The Louisiana Unified Shelter Plan is a supplement published separately to the State of Louisiana Emergency Operation Plan. The plan outlines the planning considerations surrounding the sheltering of all citizens in the State of Louisiana and identifies the common terminology and creates minimum shelter standards for any location providing sheltering in response to all hazards and events regardless of size and scope. According to the Louisiana Unified Shelter Plan, parish and local governments, supported by private relief agencies, provide initial response to mass care requirements of emergency/disaster victims and parish governments request and facilitate the implementation of authorized outside government assistance (state and federal). State and federal agencies, when requested and authorized, support the activities of parish and local governments in providing mass care. The State, through ESF-6, may provide direct initial response including the establishment and operation of state run shelters to supplement the efforts of parish and local governments.

For any event or disaster within the state of Louisiana, all parish and ESF-6 partners will establish and maintain Shelter Activation Levels. GOHSEP, in conjunction with DCFS, will set the State Mass Care activation level during an incident. State Mass Care Activation Level may differ from individual parish levels. Each level of activation will be clearly defined in the Louisiana Unified Shelter Plan to include initiating conditions for each level and actions that must be initiated on the local and state levels as a result of meeting each condition.

Mass Care involves the coordination of non-medical mass care services including the registration, evacuation and sheltering of evacuees, organizing mass feeding operations with the Louisiana Workforce Commission, providing emergency first aid at designated sites as facilitated through LDH, collecting and providing information on victims to be used to aid in the reunification of families with individuals separated by emergencies and disasters; and coordination with partners to assist with housing solutions. All mass care operations involve the close coordination of ESF-6 partners throughout the entire operational period.

#### A. PREPAREDNESS:

1. ESF 6 will develop plans, procedures, and agreements to identify acquire and mobilize the organizations, individuals and resources that will be needed to carry our mass care, housing, and human services in emergencies and disasters.
2. ESF 6 will cooperate with organizations and individuals, including local, parish, state and federal government, private industry and Non-Governmental Organizations (NGO) that have significant roles in emergencies and disasters.
3. The Secretary of DCFS will designate a DCFS ESF-6 Mass Care, Housing and Human Services Director (who will be the DCFS Emergency Preparedness Director) and the Secretary of LWC will designate an ESF-6 Mass Feeding Coordinator.
4. All agencies supporting ESF-6 or providing emergency Mass Care, Housing and Human Services support are responsible for records maintenance for operations, including all agreements and Memorandums of Understanding (MOUs) entered into for the purchase, lease or the use of the facilities, equipment and services. All cost records eligible for use after the emergency/disaster must be kept to obtain reimbursement from State and Federal Resources.

#### B. RESPONSE:

1. DCFS can, when staff is available, assist with registration and tracking of Critical Transportation Needs (CTN) and Medical Special Needs (MSN) evacuees when requested by evacuating parishes. DCFS utilizes a digital registration system for processing evacuees. Registration of companion animals is a function of the Louisiana Department of Agriculture and Forestry (LDAF).
2. DCFS, working with local governments, partnering states and the agencies supporting ESF-6 provide for the sheltering of all evacuees that are dependent upon state provided transportation out of a danger area. Emergency shelter includes the use of pre-identified shelter sites in existing structures including structures accessible to the physically challenged, creation of temporary facilities or the construction of temporary shelters, as well as the use of similar facilities outside the incident area. Pre-staging of these facilities will occur when emergencies/disasters are anticipated. Evacuees may be directed to a selected shelter facility.
3. LWC as ESF-6 co-lead, is responsible for mass feeding, which is provided to victims and emergency workers through a combination of fixed sites and mobile feeding units. Feeding operations are to be based on sound nutritional standards to include meeting requirements of victims with special dietary needs to the extent possible. The LWC ESF 6 Lead will assess the needs for mass feeding support to shelters and to emergency workers outside shelters and coordinate the provision of feeding support to satisfy such needs. The LWC lead will initiate contact and enter into close cooperation with parish shelters, feeding authorities, and Non-Governmental Organizations (NGO) to support the prompt and effective relief of immediate feeding needs in accordance with the State of Louisiana Mass Care Feeding Plan and the activation of the State's Mass Care Feeding Taskforce (LMFTF) .

### C. RECOVERY:

1. Human Services may include the provision of victim-related recovery assistance such as counseling, case management, intervention, mental health services, identification of support for persons with special needs, and employment assistance. Access to these services may be provided at shelters during sheltering operations. This assistance may be extended into the communities when a Disaster Recovery Center (DRC) is opened as a result of the transition of operations to the recovery phase. ESF-6 will assist in providing on-going Human Services and support to evacuees through the Multi-Agency Shelter Transition Team (MASTT) process as evacuees' transition to self-sustainment. The recovery process is a multi-agency coordination effort led by ESF 14; and specifically through Recovery Support Function (RSF) 3, for Health and Social Services recovery.
2. Feeding may include the leverage of food assistance programs such as the Disaster Supplemental Nutrition Assistance Program (DSNAP) administered by DCFS, which may be made available if the incident dictates the need and falls within the leverage of additional commodities to supplement feeding. ESF 6 leads will continue to contact and cooperate with feeding authorities and NGO food and nutrition supported networks to transition feeding response strategies to recovery in accordance with the Louisiana Mass Care Feeding Plan and the activation of the State's Mass Care Feeding Taskforce (LMFTF)
3. Housing involves the use of Emergency Shelter, Extended Shelter and Transitional Shelter strategies in the provision of assistance for short- and long-term housing needs of disaster victims. The recovery process is a multi-agency coordination effort led by ESF-14, and specifically through Recovery Support Function (RSF) 4, Housing recovery led by Louisiana Housing Corporation (LHC).

## IV. ORGANIZATION AND RESPONSIBILITIES

- A. The Department of Children & Family Services has primary responsibility for the implementation and administration of Mass Care, Housing, and Human Services to disaster victims.
- B. The Louisiana Workforce Commission has primary responsibility for Mass Feeding during disasters.
- C. The Support Agencies for ESF 6 activities are responsible for developing and maintaining plans, procedures, and asset inventories to support the lead agencies for ESF 6. Support agencies for ESF 6 include the following:
  1. Department of Public Safety and Corrections
  2. Governor's Office of Homeland Security and Emergency Preparedness
  3. Louisiana Housing Corporation
  4. Louisiana National Guard
  5. Department of Agriculture and Forestry
  6. Department of Culture, Recreation and Tourism
  7. Department of Economic Development

8. Department of Education
9. Department of Environmental Quality
10. State Fire Marshal
11. Governor's Office of Disability Affairs
12. Governor's Office of Elderly Affairs
13. Louisiana Department of Health
14. Louisiana State University System and Ag Center
15. Department of Insurance
16. Department of Labor
17. Department of Natural Resources
18. Louisiana Public Service Commission
19. Louisiana Board of Regents
20. Department of Veterans Affairs
21. Department of Revenue
22. Department of Transportation and Development
23. Department of Wildlife and Fisheries
24. Louisiana State Police
25. Office of the Lieutenant Governor
26. State Treasurer
27. Non-Governmental Organizations (NGO)
28. Southern University System

**V. COMMAND AND CONTROL**

Command and Control will be exercised as provided in the Basic Plan.

**VI. CONTINUITY OF GOVERNMENT**

Continuity of Government will be as provided in the Basic Plan.

## **VII. ADMINISTRATION AND LOGISTICS**

- A. If state resources are inadequate for the tasks assigned, the ESF 6 Leads will report the situation and needs to GOHSEP, which will assist in seeking additional resources from other states through EMAC and from the federal government, pursuant to a Presidential Disaster Declaration.
- B. Every agency providing assistance with mass care, emergency assistance, housing and human services will maintain accurate records of the operations, including information related to costs incurred during disaster operations that can be used after the emergency to obtain reimbursement from state or federal resources.

## **VIII. PLAN MAINTENANCE**

The ESF 6 Mass Care, Housing and Human Services Leads are responsible for developing, maintaining and coordinating plans, procedures and agreements in support of this emergency support function.

## **IX. AUTHORITIES AND REFERENCES**

Authorities and references are included in the basic plan.

## **X. APPENDICES**

- A. ESF 6 Responsibility Chart
- B. State-Federal Crosswalk

**APPENDIX 1 – ESF 6  
MASS CARE, HOUSING, AND HUMAN SERVICES RESPONSIBILITY CHART**

<b>Agency support to the Louisiana Department of Children &amp; Family Services and the Louisiana Workforce Commission</b>	<b>Shelter</b>	<b>Mass Feeding</b>	<b>Housing</b>	<b>Individual Assistance</b>	<b>Community Action</b>	<b>Transportation</b>
Department of Corrections	X	X		X	X	
Governor’s Office of Homeland Security and Emergency Preparedness	X	X	X	X	X	X
Louisiana Housing Corporation	X		X	X	X	
Louisiana National Guard	X					X
Department of Agriculture & Forestry	X	X				
Department of Culture, Recreation and Tourism	X				X	
Department of Economic Development	X					
Department of Education	X	X				
State Fire Marshal Office	X				X	
Governor’s Office of Disability Affairs	X			X	X	
Governor’s Office of Elderly Affairs	X			X	X	
Louisiana Department of Health	X			X		
Department of Veterans Affairs	X			X		
Louisiana State University System and Ag Center	X			X	X	
Louisiana Board of Regents	X	X	X	X	X	X
Department of Labor	X					
Department of Revenue	X		X	X	X	X
Department of Insurance	X		X	X		
Department of Natural Resources	X					
Department of Transportation and Development						X
Louisiana State Police	X			X		
Non-Governmental Organizations (NGO) *	X	X	X	X	X	
Office of Lieutenant Governor						
Department of Environmental Quality	X					
Department of Treasury	X					
Department of Wildlife and Fisheries	X					
Southern University System	X					
Louisiana Public Service Commission	X			X		
<b>* To include private relief organizations (i.e. American Red Cross, United Way of Louisiana and 2-1-1, Salvation Army, Mennonite Disaster Service, etc.); private industry; professional associations and participants in mutual aid agreements, etc.</b>						

**APPENDIX 2 – ESF – 6**  
**MASS CARE, HOUSING, AND HUMAN SERVICES STATE – FEDERAL CROSSWALK**

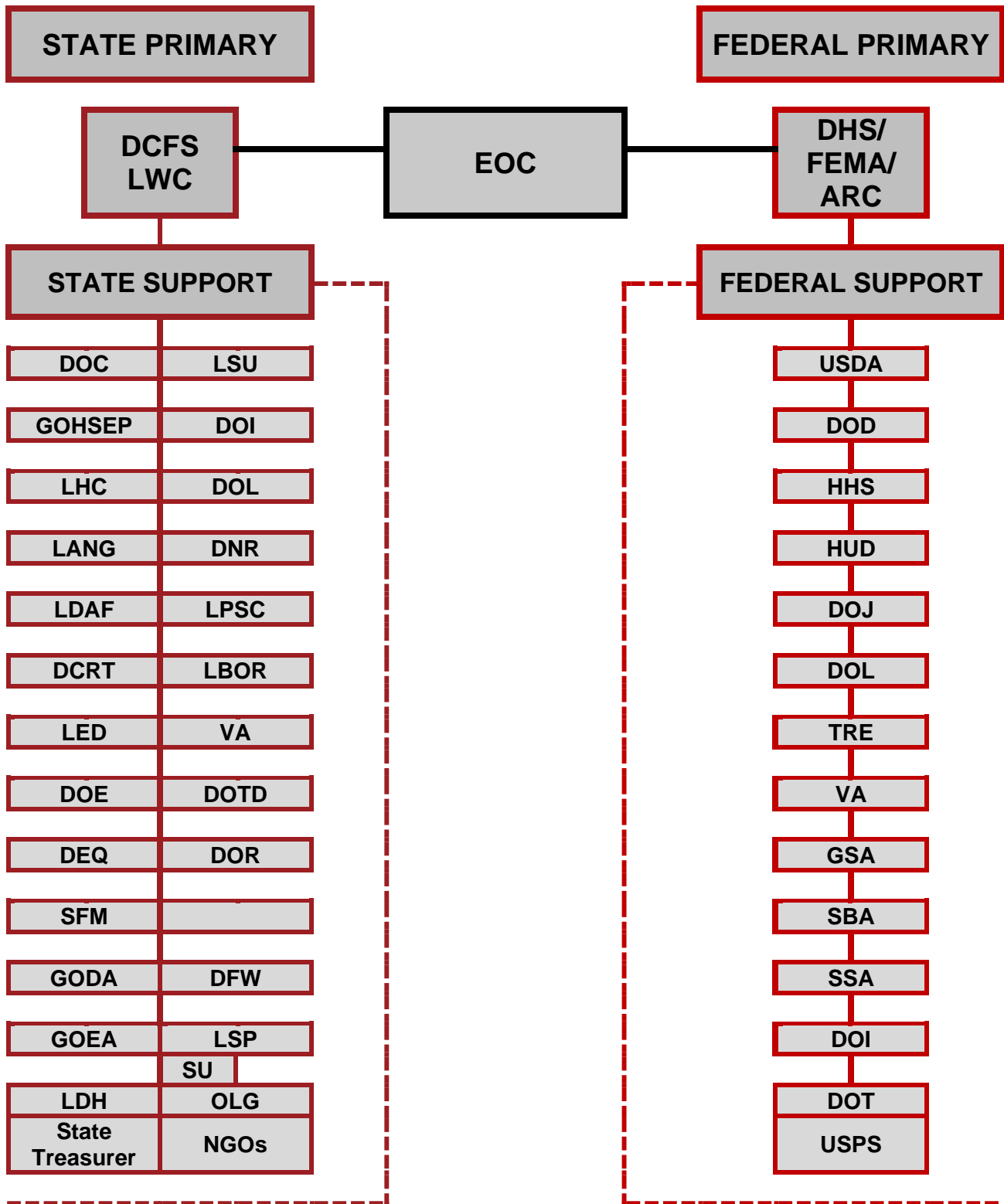



# **EMERGENCY SUPPORT FUNCTION 7**

## **RESOURCE SUPPORT ANNEX**

### **I. PURPOSE**

ESF 7 provides the Resource Support activities needed in emergencies and disasters to support parish requests and response efforts.

### **II. SCOPE**

ESF 7 Resource Support deals with the personnel, services, facilities, equipment, materials and supplies needed for emergency and disaster operations to support parish requests that cannot be fulfilled with any State owned resources.

### **III. CONCEPT OF OPERATIONS**

ESF 7 Resource Support has GOHSEP and Louisiana National Guard as the Primary Responsible agencies.

#### **A. MITIGATION:**

GOHSEP & LANG will designate an ESF 7 Resource Support Coordinator to organize and administer the ESF.

#### **B. PREPAREDNESS:**

1. The ESF 7 Coordinator will develop plans, procedures, arrangements and agreements to identify, acquire and mobilize resources for emergencies and disasters. The ESF 7 Coordinator will develop and maintain information and liaison with agencies and organizations at local, parish, state and federal government, private industry and Non-Governmental Organizations (NGO) that could furnish assistance in an emergency or disaster.

#### **C. RESPONSE:**

1. As an emergency develops, the ESF 7 Coordinator will assess the impact of the threat and potential needs for resources. Based on the initial assessment, the coordinator will activate and mobilize those support agencies whose capabilities would best be suited to responding to that emergency.
2. The ESF-7 Coordinator will request resources via the Federal Emergency Management Agency or Emergency Management Assistance Compact pursuant to LRS 29:733. If an emergency creates needs that grow beyond local, parish and state resources, the ESF 7 Coordinator will call for resources to be brought in from elsewhere, including donated goods. The coordinator will activate staging areas, warehouses and other storage and logistics facilities and request Non-Governmental Organizations (NGO) to process and distribute the resources to the areas of greatest need.
3. The ESF-7 Coordinator will ensure that load limits and other restrictions on trucks carrying emergency supplies are suspended where needed, and escorts are provided for critical shipments.

#### **D. RECOVERY:**

Resource Support activities will continue as long as they are needed after the conclusion of the emergency or disaster. The coordinator will continue to monitor resource needs to determine when activities can cease.

#### **IV. ORGANIZATION AND RESPONSIBILITIES**

- A. GOHSEP and the Louisiana National Guard have primary responsibility for obtaining, organizing, and coordinating resource support.
- B. The support agencies for resource support and logistics are responsible for developing and maintaining plans, procedures, and asset inventories to support the primary coordinator. Support agencies include, but are not limited to:
  - 1. Department of Agriculture & Forestry
  - 2. Department of Culture, Recreation, and Tourism
  - 3. Department of Economic Development
  - 4. Department of Environmental Quality
  - 5. Division of Administration
  - 6. Louisiana Department of Health
  - 7. Louisiana Workforce Commission
  - 8. Louisiana State University System
  - 9. University of Louisiana at Lafayette/ NIMSAT
  - 10. Louisiana Business Emergency Operations Center
  - 11. Department of Natural Resources
  - 12. Louisiana Board of Regents
  - 13. Department of Children and Family Services
  - 14. Louisiana State Police
  - 15. Department of Transportation & Development
  - 16. Department of the Treasury
  - 17. Office of the Lieutenant Governor
  - 18. Non-Governmental Organizations (NGO)

#### **V. COMMAND AND CONTROL**

Command and Control will be exercised as provided in the Basic Plan.

## **VI. CONTINUITY OF GOVERNMENT**

Continuity of government will be as provided in the Basic Plan.

## **VII. ADMINISTRATION AND LOGISTICS**

- A. If local, parish and state resources are inadequate to the tasks assigned; the ESF 7 Coordinators will seek additional resources from EMAC and from the federal government pursuant to a Presidential Disaster Declaration.
- B. Every agency providing resource support services will maintain records of the operations, including cost records that can be used after the emergency to obtain reimbursement from state or federal resources.

## **VIII. PLAN MAINTENANCE**

The ESF 7 Resource Support Coordinators are responsible for developing, maintaining and coordinating plans, procedures, arrangements, and agreements in support of this ESF.

## **IX. AUTHORITIES AND REFERENCES**

Authorities and references are included in the Basic Plan.

## **X. APPENDICES**

- A. ESF 7 Responsibility Chart
- B. State-Federal Crosswalk

**APPENDIX 1 – ESF 7  
RESOURCE SUPPORT RESPONSIBILITY CHART**

<b>Agency support to the Governor’s Office of Homeland Security and Emergency Preparedness and the Louisiana National Guard.</b>	<b>Resource Listing</b>	<b>Mutual Aid Agreements</b>	<b>Manpower</b>	<b>Equipment</b>	<b>Warehousing</b>
Department of Agriculture & Forestry	X	X	X	X	
Department of Culture, Recreations and Tourism	X	X	X		
Department of Economic Development	X	X	X		
Department of Environmental Quality	X	X	X		
Division of Administration	X	X	X		
Louisiana State University System	X	X	X	X	
Louisiana Business Emergency Operations Center	X	X	X		
Louisiana Department of Health	X	X	X	X	
Louisiana Workforce Commission	X	X	X		
Department of Natural Resources	X	X	X		
Louisiana Board of Regents	X	X	X	X	X
Department of Children and Family Services	X	X	X		
Louisiana State Police	X	X	X		
Department of Transportation & Development	X	X	X		
Department of Treasury	X	X	X		
Non-Governmental Organizations (NGO) *	X	X	X	X	X
* To include private relief organizations (i.e. American Red Cross, Salvation Army, Mennonite Disaster Service, etc.); private industry; professional associations and participants in mutual aid agreements, etc.					

**APPENDIX 2 – ESF 7  
RESOURCE SUPPORT STATE – FEDERAL CROSSWALK**

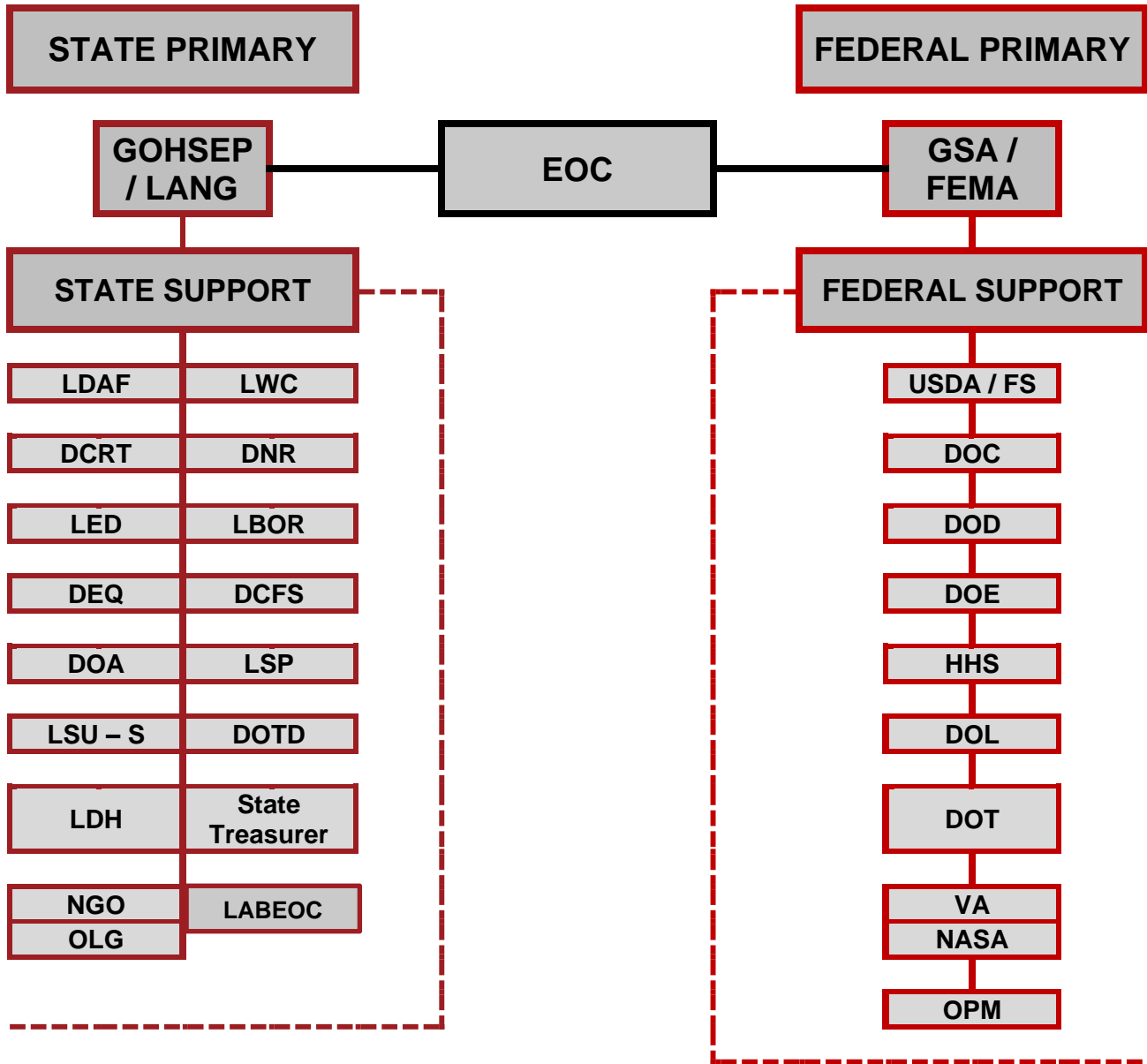

## **EMERGENCY SUPPORT FUNCTION 8 PUBLIC HEALTH AND MEDICAL SERVICES ANNEX**

### **I. PURPOSE**

ESF 8 coordinates public health and sanitation, emergency medical services, hospital services, and behavioral health services to disaster victims and responders, to supplement and support disrupted or overburdened local medical personnel and facilities and relieve personal suffering and trauma. In addition, ESF 8 provides coordination of the State's Catastrophic Mass Fatality Plan which may be enacted during a state declaration.

### **II. SCOPE**

- A. Public Health and Sanitation refers to the services, equipment and staffing support needed to protect the health and general welfare of the public from communicable diseases, contamination and epidemics; the development and monitoring of health information; inspection of food and water quality and sanitation measures; immunizations; laboratory testing; animal and vector control; inspection of public drinking water supplies; sewage treatment services; public health information/ education and monitoring of environmental health hazards.
- B. Medical care refers to emergency and resident medical care; doctors, nurses, technicians, supplies, equipment, ambulance and emergency medical services, emergency psychiatric and addiction services, hospitals, and other healthcare organizations, planning and operation of facilities and services.
- C. Behavioral Health refers to the provision and/or coordination of professional personnel, services and facilities essential to relieve survivor trauma and other psychological or addiction related problems caused or aggravated by a disaster or its aftermath.
- D. Pre-hospital emergency services and medical transport refers to the coordination of Emergency Medical System (EMS) professionals, equipment and supplies to address disaster response surge, triage, treatment and medical transport.
- E. The State Catastrophic Mass Fatality Plan refers to the coordination of mortuary operations, victim identification, family assistance, grief and loss support, and victim reunification which may be activated during a State Declared Emergency. The plan also includes details of stakeholder and parish participation in the Cemetery Response Task Force.

### **III. CONCEPT OF OPERATIONS**

The Louisiana Department of Health (LDH) is the primary responsible agency for coordinating medical support in State-operated Medical Special Needs Shelter (s) and Points of Dispensing (PODs). LDH is the primary agency for coordinating with support agencies and/or organizations to facilitate health care and hospital planning with public and private medical facilities. The Louisiana Department of Health oversees and directs a regional network of coordinators representing hospital, EMS and public health disciplines. This network is essential for coordination and communication between Parishes and the State.

The Louisiana State University (LSU) System is support to LDH in coordinating the provision of Medical providers in State-operated Medical Special Needs Shelters. LSU shall support the Medical Special Needs Shelter operations with available resources.

The parishes shall have primary responsibility for their citizens to include addressing health and medical activities and needs. Towards this end, the parishes shall:

- Develop comprehensive plans to include health and medical needs of their parish (i.e. Inclusive of hospitals, nursing homes, home health agencies, and behavioral health agencies that are in their parish)
- Identify gaps
- Facilitate efforts to close gaps
- Coordinate with local EMS services for transportation.

Local assets and parish contingency contracts should be used before requesting state assistance. Once the parishes have exhausted local assets and contracts, the state shall:

- Support the parishes by developing the necessary contingency contracts for medical resources (i.e. ambulances, personnel, etc.)
- Coordinate the request of parishes so as to develop a comprehensive state plan

Once the state has exhausted its resources and contingency contracts, the state shall coordinate requests for additional assistance with the federal government.

Home Health and hospice patients are part of the general community as are other vulnerable individuals that may self-present during an evacuation. The parish has a responsibility to identify these individuals and to coordinate with the State the possible transportation assets that may be needed (that exceeds their parish efforts). Regardless of an individuals' disability, there are only so many types of transportation vehicles that can be "assigned" to the parish to support their evacuation plans – school bus, coach bus, ambulance, para-transit vehicles or plane. The parishes are responsible for getting their citizens to Parish Pick-Up Points.

#### A. MITIGATION:

The Secretary of LDH will designate an ESF 8 Public Health and Medical Services Coordinator (ESF 8 Emergency Preparedness Coordinator) to organize and administer the ESF 8 functions.

#### B. PREPAREDNESS:

1. The ESF 8 Emergency Preparedness Coordinator will develop plans, procedures, arrangements and agreements to identify, acquire and mobilize public health, medical, behavioral health, and mass fatalities resources for emergencies and disasters.
2. The ESF 8 Emergency Preparedness Coordinator will develop and maintain information and serve as a liaison with public health, medical, behavioral health and mass fatality resources in local, parish, state government, federal government, private industry and Non-Governmental Organizations (NGO) that could furnish assistance in an emergency or disaster.
3. LDH will receive and review the emergency preparedness plans of nursing homes in Acadia, Ascension, Assumption, Calcasieu, Cameron, Iberia, Jefferson, Jefferson Davis, Lafayette, Lafourche, Orleans, Plaquemines, St. Bernard, St. Charles, St. James, St. John the Baptist, St. Mary, St. Martin, St. Tammany, Tangipahoa, Terrebonne, and Vermilion Parishes annually or when the plan is changed, modified, or amended by the nursing home during the year in accordance with RS 29:766.

### C. RESPONSE:

1. As an emergency develops, the ESF 8 Emergency Preparedness Coordinator will activate and mobilize personnel, facility and material resources in accordance to the anticipated threat and state declared emergency.
2. The ESF 8 Emergency Preparedness Coordinator will have the disaster area surveyed as soon as possible to determine whether the disaster has created any public health problems or threats. The coordinator will direct the appropriate resources to the area to remove and solve problems and suppress any threats to health and sanitation.
3. In the event of any situation in which there are more human bodies to be recovered and examined than can be handled by parish resources, the ESF 8 Emergency Preparedness Coordinator will activate the State Catastrophic Mass Fatality Plan.
4. In the event of cemetery disruptions, ESF-8 will coordinate with the Cemetery Response Task Force to respond to such matters.

### D. RECOVERY:

Public health, medical services, behavioral health, mass fatality and priority recovery activities will continue as long as deemed necessary by ESF 8 after the conclusion and community assessment of the emergency or disaster. The ESF 8 Emergency Preparedness Coordinator will continue to gather information on the restoration of health, medical and sanitation facilities and assets to acceptable levels.

## IV. ORGANIZATION AND RESPONSIBILITIES

- A. The Louisiana Department of Health has primary responsibility for providing and coordinating medical support the following:
  1. Medical support to State-operated Medical Special Needs Shelters.
  2. Medical support to Points of Dispensing (POD) operations.
  3. Behavioral health intervention and crisis counseling support and referrals.
- B. After the parish has exhausted resources and contracts, LDH has primary responsibility for coordinating hospital care and state-operated Medical Special Needs Shelters. LSU shall support LDH with these responsibilities with available resources.
- C. State ESF 8 has done due diligence in identifying/developing a contract for surge ambulances (support ESF 1) and in identifying/security State-Operated Medical Special Needs Shelters and Federal Medical Stations.
- D. Expectations:
  1. Parishes:
    - a. Parishes are responsible for getting their citizens to Parish Pick-Up Points
    - b. Parishes are responsible for assisting LDH with planning and facilitating general-public non-medical Point of Dispensing site(s) for mass dispensing operations.



2. State:
  - a. ESF 8 Supplement 6 includes plans for the following:
    - i. Medical Special Needs Shelter Network
    - ii. Federal Medical Stations
    - iii. Surge Ambulance Plan
    - iv. Medical Institution Evacuation Plan
    - v. Strategic National Stockpile Plan
    - vi. ESF 8 Health and Medical Preparedness and Response Network Coalition Plan
- E. LDH has primary responsibility for coordinating hospital care and state-operated Medical Special Needs Shelters. LSU shall support LDH with these responsibilities with available resources.
- F. ESF 8 will be responsible for the management, coordination and execution of the State Catastrophic Mass Fatality Plan and shall participate in the Cemetery Response Task Force.
- G. The Support Agencies / Organizations for Public Health and Medical Services are responsible for developing and maintaining plans, procedures and asset inventories to support the ESF 8 Emergency Preparedness Coordinator. Support Agencies / Organizations include, but are not limited to:
  1. Louisiana National Guard
  2. Department of Agriculture and Forestry
  3. Department of Corrections
  4. Department of Children and Family Services
  5. Department of Environmental Quality
  6. Louisiana State University System
  7. Louisiana Board of Regents
  8. State Fire Marshal
  9. Louisiana Workforce Commission
  10. Department of Transportation and Development
  11. Department of Veterans Affairs
  12. Non-Governmental Organizations (NGO)
  13. Louisiana Hospital Association
  14. Louisiana Primary Care Association
  15. Louisiana Ambulance Alliances
  16. Louisiana Nursing Home Association

17. Louisiana Emergency Response Network

18. Department of Justice - Office of the Attorney General

**V. COMMAND AND CONTROL**

Command and control will be directed by the Louisiana Department of Health (LDH) as provided in the Basic Plan.

**VI. CONTINUITY OF GOVERNMENT**

Continuity of government will be as provided in the Basic Plan.

**VII. ADMINISTRATION AND LOGISTICS**

A. If state resources are inadequate to the tasks assigned, the ESF 8 Emergency Preparedness Coordinator will report the situation and the needs to GOHSEP, which will seek additional resources from EMAC and from the federal government pursuant to a Presidential Disaster Declaration.

B. Every agency providing emergency public health and medical services support will maintain records of the operations, including cost records that can be used after the emergency to obtain reimbursement from state or federal sources.

**VIII. PLAN MAINTENANCE**

The ESF 8 Emergency Preparedness Coordinator is responsible for developing, maintaining and coordinating plans, procedures, arrangements, and agreements in support of this ESF.

**IX. AUTHORITIES AND REFERENCES**

Authorities and references are included in the Basic Plan.

**X. APPENDICES**

A. ESF 8 Responsibility Chart

B. State-Federal Crosswalk

**APPENDIX 1 – ESF 8  
PUBLIC HEALTH AND MEDICAL SERVICES RESPONSIBILITY CHART**

<b>Agency support to the Louisiana Department of Health.</b>	<b>Facilities</b>	<b>Personnel, Supplies, &amp; Equipment</b>	<b>Medical Consultation</b>	<b>Laboratory Facilities</b>	<b>Field Hospitals/Shelters</b>	<b>Medical – Emergency Procurement</b>	<b>Technical Assistance – Food Quality</b>	<b>Water Quality Control &amp; Waste</b>	<b>Communications Equipment</b>	<b>Transportation – Air</b>	<b>Transportation – Land</b>	<b>Mass Fatality</b>
Louisiana National Guard		X			X	X			X	X	X	X
Department of Agriculture & Forestry				X			X		X	X	X	
Department of Corrections	X	X										X
Department of Children and Family Services	X	X			X							
Department of Environmental Quality		X							X			
Louisiana State University System	X	X	X	X	X	X		X				X
Louisiana Board of Regents	X	X										
State Fire Marshal		X							X		X	
Louisiana Workforce Commission					X							
Department of Transportation & Development				X							X	
Department of Veterans Affairs		X	X			X	X					
Non-Governmental Organizations (NGO) *	X	X	X	X	X	X	X	X	X	X	X	
Louisiana Hospital Association	X	X	X	X		X						
Louisiana Nursing Home Association	X	X	X									
Louisiana Primary Care Association	X	X	X			X						
Louisiana Ambulance Alliance	X	X							X	X	X	
Louisiana Emergency Response Network	X	X	X						X	X	X	
* To include private relief organizations (i.e. American Red Cross, Salvation Army, Mennonite Disaster Service, etc.); private industry; professional associations and participants in mutual aid agreements, etc.												

**APPENDIX 2 – ESF 8  
PUBLIC HEALTH AND MEDICAL SERVICES STATE-FEDERAL CROSSWALK**

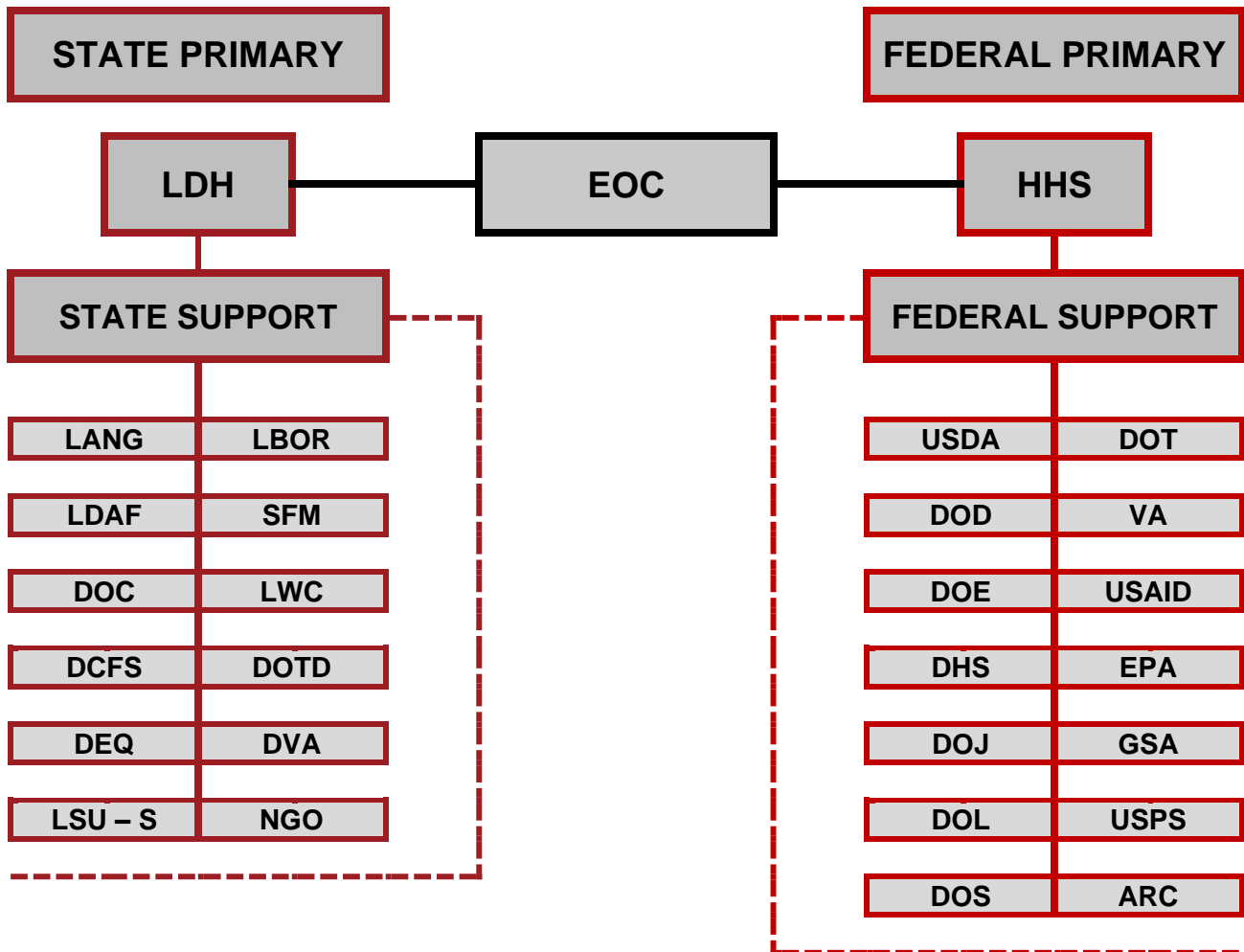

**EMERGENCY SUPPORT FUNCTION 9  
SEARCH AND RESCUE ANNEX**

**I. PURPOSE**

ESF 9 provides assistance in all activities associated with Search and Rescue (SAR) operations which are beyond the capabilities of the local governments within the affected areas, to coordinate the integration of personnel and equipment resources.

**II. SCOPE**

State assistance under this ESF shall include the identification, mobilization, and coordination of all State and private industry and resources for the following activities:

- A. SEARCH – All activities directed toward locating individuals missing or reported missing, in jeopardy, or possible jeopardy, of life and limb.
- B. RESCUE – All activities directed toward and requiring the utilization of organized and trained personnel to extricate persons trapped in damaged buildings, shelters, vehicles and other enclosures, or from remote or contaminated areas; and to provide first aid or emergency medical treatment and arrange for removal of persons to safety.

**III. CONCEPT OF OPERATIONS**

A. MITIGATION:

The Secretaries of the Department of Wildlife and Fisheries and the Louisiana Office of State Fire Marshal will appoint an ESF 9 Search and Rescue Coordinator to organize and coordinate SAR services.

B. PREPAREDNESS:

The Coordinator will develop plans, procedures, and agreements to mobilize SAR resources for operations on land, water and in the air in case of need.

C. RESPONSE:

The Coordinator will mobilize SAR resources as needed for both general area and focused search and rescue missions.

D. RECOVERY:

The Coordinator will continue to coordinate SAR missions as requested. When SAR is no longer required the coordinator will close out all missions and render a report.

**IV. ORGANIZATION AND RESPONSIBILITIES**

- A. The Louisiana Department of Wildlife and Fisheries and the Louisiana Office of State Fire Marshal has the primary responsibility for search and rescue. That responsibility

includes coordination with support agencies to make sure that they develop and maintain plans and procedures.

B. The support agencies for search and rescue are responsible for developing and maintaining plans, procedures, and asset inventories to support the ESF 9 Coordinator. Support agencies include, but are not limited to:

1. Louisiana National Guard
2. Department of Agriculture and Forestry
3. Louisiana Department of Health
4. Department of Corrections
5. Department of Culture, Recreation & Tourism
6. Office of Lieutenant Governor
7. Louisiana State Police
8. Department of Transportation and Development
9. Louisiana State University Fire and Emergency Training Institute
10. Department of Revenue - Office of Alcohol and Tobacco Control
11. Non-Governmental Organizations (NGO)

## **V. COMMAND AND CONTROL**

Command and control will be exercised as provided in the Basic Plan.

## **VI. CONTINUITY OF GOVERNMENT**

Continuity will be as provided in the Basic Plan.

## **VII. ADMINISTRATION AND LOGISTICS**

A. If SAR needs exceed available resources, the ESF 9 Coordinator will report the situation to the Governor's Office of Homeland Security and Emergency Preparedness, which will seek additional resources from EMAC and from the federal government pursuant to a Presidential Disaster Declaration.

B. Every agency providing SAR support will maintain records of the operations, including cost records that can be used after the emergency to obtain reimbursement from state or federal sources.

## **VIII. PLAN MAINTENANCE**

The ESF 9 SAR Coordinator is responsible for developing, maintaining and coordinating plans, procedures, arrangements, and agreements in support of this ESF.

## **IX. AUTHORITIES AND REFERENCES**

Authorities and references are included in the Basic Plan.

## **X. APPENDICES**

A. ESF 9 Responsibility Chart

B. State-Federal Crosswalk

**APPENDIX 1 – ESF 9  
SEARCH AND RESCUE RESPONSIBILITY CHART**

<b>Agency support to the Louisiana Department of Wildlife &amp; Fisheries</b>	<b>Search &amp; Rescue, Recovery – Land</b>	<b>Search &amp; Rescue, Recovery – Air</b>	<b>Search &amp; Rescue, Recovery – Water</b>	<b>Identification / Investigation</b>	<b>Transportation – Air</b>	<b>Transportation – Land</b>
Louisiana National Guard	X	X	X		X	X
Department of Agriculture and Forestry	X	X	X		X	X
State Fire Marshal	X		X	X		X
Department of Corrections	X					
Department of Culture, Recreation & Tourism	X					X
Office of the Lieutenant Governor	X					X
Louisiana State Police	X	X		X	X	X
Department of Transportation and Development						X
Louisiana State University Fire and Emergency Training Institute	X	X				
Department of Revenue – Office of Tobacco and Control	X					
Non-Governmental Organizations (NGO) *	X	X	X		X	X

**\* To include private relief organizations (i.e. American Red Cross, Salvation Army, Mennonite Disaster Service, etc.); private industry; professional associations and participants in mutual aid agreements, etc.**



**APPENDIX 2 – ESF 9  
SEARCH AND RESCUE STATE – FEDERAL CROSSWALK**

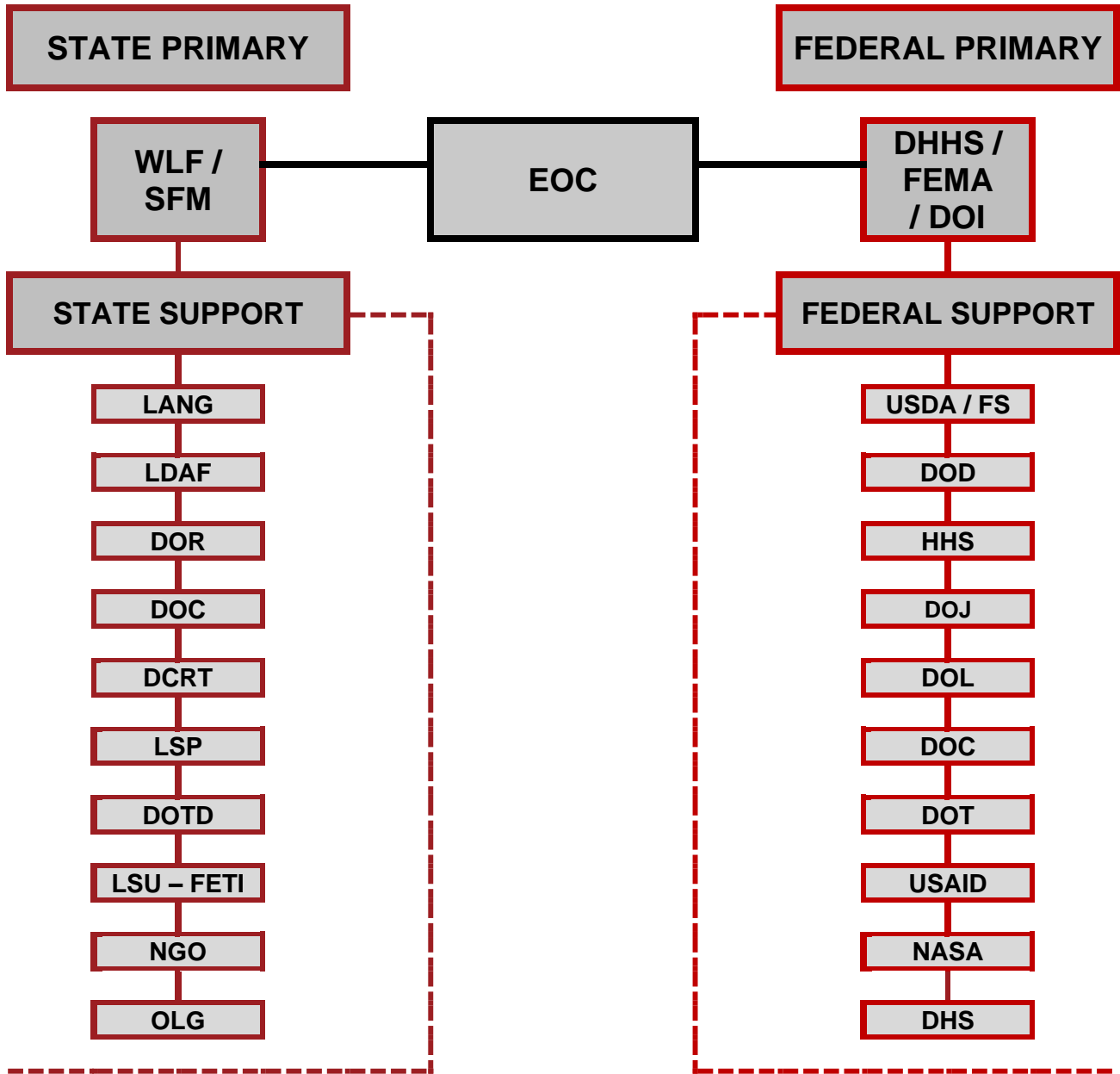

**EMERGENCY SUPPORT FUNCTION 10  
OIL SPILL AND HAZARDOUS MATERIALS AND RADIATION ANNEX**

**I. PURPOSE**

ESF 10 provides for an effective and efficient response and recovery from oil spill, hazardous materials (HAZMAT) and radiological incidents that threaten the lives and property of the citizens of Louisiana and the environment of the state. This ESF coordinates state resources responding to and remedying these incidents.

**II. SCOPE**

State action in this function can range from the detection of a release or spill, through the provision of assistance to local government and support of response actions, to procurement of a contractor, to coordination of joint local, parish, state and federal operations, to the final inspection and approval of remedial and restoration work.

**III. CONCEPT OF OPERATIONS**

There are three primary agencies under ESF 10: The Louisiana Oil Spill Coordinator's Office (LOSCO) is the primary agency for oil spills, which is under LOSCO's statutory and regulatory authority. The Louisiana State Police (LSP) is the primary agency for hazardous materials incidents, which is under the Louisiana State Police Hazardous Materials/Explosives Unit's statutory and regulatory authority. The Louisiana Department of Environmental Quality (LDEQ) is the primary agency for incidents involving radioactive materials, which is under LDEQ's statutory and regulatory authority.

**A. MITIGATION:**

LOSCO, LSP, and LDEQ will designate ESF 10 coordinator(s) to organize and administer the ESF.

**B. PREPAREDNESS:**

1. The ESF 10 Coordinators will develop plans, procedures, arrangements, and agreements to identify, mobilize, and coordinate oil spill, HAZMAT, and radiological expertise and resources.
2. The ESF 10 Coordinators will develop and maintain information and liaison with public and private agencies and organizations that could furnish expertise and assistance to ensure working relationships in cases of emergencies or natural disasters.
3. Various support agencies have responsibilities detailed in Supplement 6.

**C. RESPONSE:**

1. The owners/lessees, processors, transporters and custodians of oil and petroleum products, hazardous materials, and radiological sources have the statutory requirement for reporting releases and spills, activating response and remediation activities, and paying for the cost of such activities incurred by governmental or private organizations.
2. When an oil spill, HAZMAT, or radiological event occurs, the ESF 10 Coordinator for the primary agency for that event will ensure that any people who might be affected by the incident

are alerted to take appropriate protective action. The ESF 10 Coordinator will alert, activate and mobilize resources to assess the impact and determine the extent of the needed response.

**D. RECOVERY:**

Oil Spill/HAZMAT and radiological operations will continue until the leak, spill or release has been stopped, contained and cleaned up and the area has been restored.

**IV. ORGANIZATION AND RESPONSIBILITIES**

A. LOSCO is the primary agency for oil spill operations.

B. LSP is the primary agency for HAZMAT operations.

C. LDEQ is the primary agency for radiation incidents.

D. The support agencies for oil spill, HAZMAT, and radiological operations are responsible for developing and maintaining plans, procedures, and asset inventories to support ESF 10. Support agencies include, but are not limited to:

1. Governor's Office of Homeland Security and Emergency Preparedness
2. Louisiana National Guard
3. Louisiana Department of Agriculture and Forestry
4. Louisiana State Fire Marshal
5. Louisiana State University System
6. Louisiana Department of Health
7. Louisiana Department of Natural Resources
8. Louisiana Department of Transportation and Development
9. Louisiana Department of Wildlife and Fisheries
10. Coastal Protection and Restoration Authority
11. Non-Governmental Organizations

**V. COMMAND AND CONTROL**

Command and Control will be exercised as provided in the Basic Plan.

**VI. CONTINUITY OF GOVERNMENT**

Continuity of Government will be as provided in the Basic Plan.

**VII. ADMINISTRATION AND LOGISTICS**

- A. If State resources are inadequate to the tasks assigned, the ESF 10 Coordinators will report the situation to GOHSEP, which will seek additional resources via the Emergency Management Assistance Compact (EMAC) (La. R.S. 29:733 – Interstate Emergency Preparedness and Disaster Compact) and from the federal government pursuant to a Presidential Disaster Declaration.
- B. The ESF 10 Coordinators may find it necessary to contract with private industry for specialized remedial action to stop the release or leak and restore the area.
- C. Every agency providing oil spill, HAZMAT, or radiation support will maintain records of the operations, including cost records that can be used after the emergency to recover costs from the responsible party or from state or federal sources

#### **VIII. PLAN MAINTENANCE**

The ESF 10 Coordinators are responsible for developing, maintaining and coordinating plans, procedures, arrangements and agreements in support of this ESF.

#### **IX. AUTHORITIES AND REFERENCES**

Authorities and references are included in the Basic Plan.

#### **X. APPENDICES**

- A. ESF 10 Responsibility Chart
- B. State-Federal Crosswalk

**APPENDIX 1 – ESF 10  
OIL SPILL, HAZARDOUS MATERIALS, AND RADIOLOGICAL  
RESPONSIBILITY CHART**

Agency support to the Louisiana Oil Spill Coordinators Office (Oil Spill), the Louisiana State Police (HAZMAT), and the Louisiana Department of Environmental Quality (Radiological)	Coordination	Analysis Support	Personnel	Equipment	Communications	Remediation
Governor’s Office of Homeland Security and Emergency Preparedness	X				X	
Louisiana National Guard			X	X	X	
Department of Agriculture and Forestry		X	X	X	X	X
State Fire Marshal			X	X	X	
Louisiana State University System		X	X			
Louisiana Department of Health		X	X			
Department of Natural Resources		X	X			X
Department of Transportation and Development		X	X	X	X	X
Department of Wildlife and Fisheries			X	X	X	X
Coastal Protection and Restoration Authority		X	X			
Non-Governmental Organizations (NGO)s		X	X	X	X	
* To include private relief organizations (i.e. American Red Cross, Salvation Army, Mennonite Disaster Service, etc.); private industry; professional associations and participants in mutual aid agreements, etc.						

**APPENDIX 2 – ESF 10  
OIL SPILL, HAZARDOUS MATERIALS, AND RADIOLOGICAL  
STATE – FEDERAL CROSSWALK**

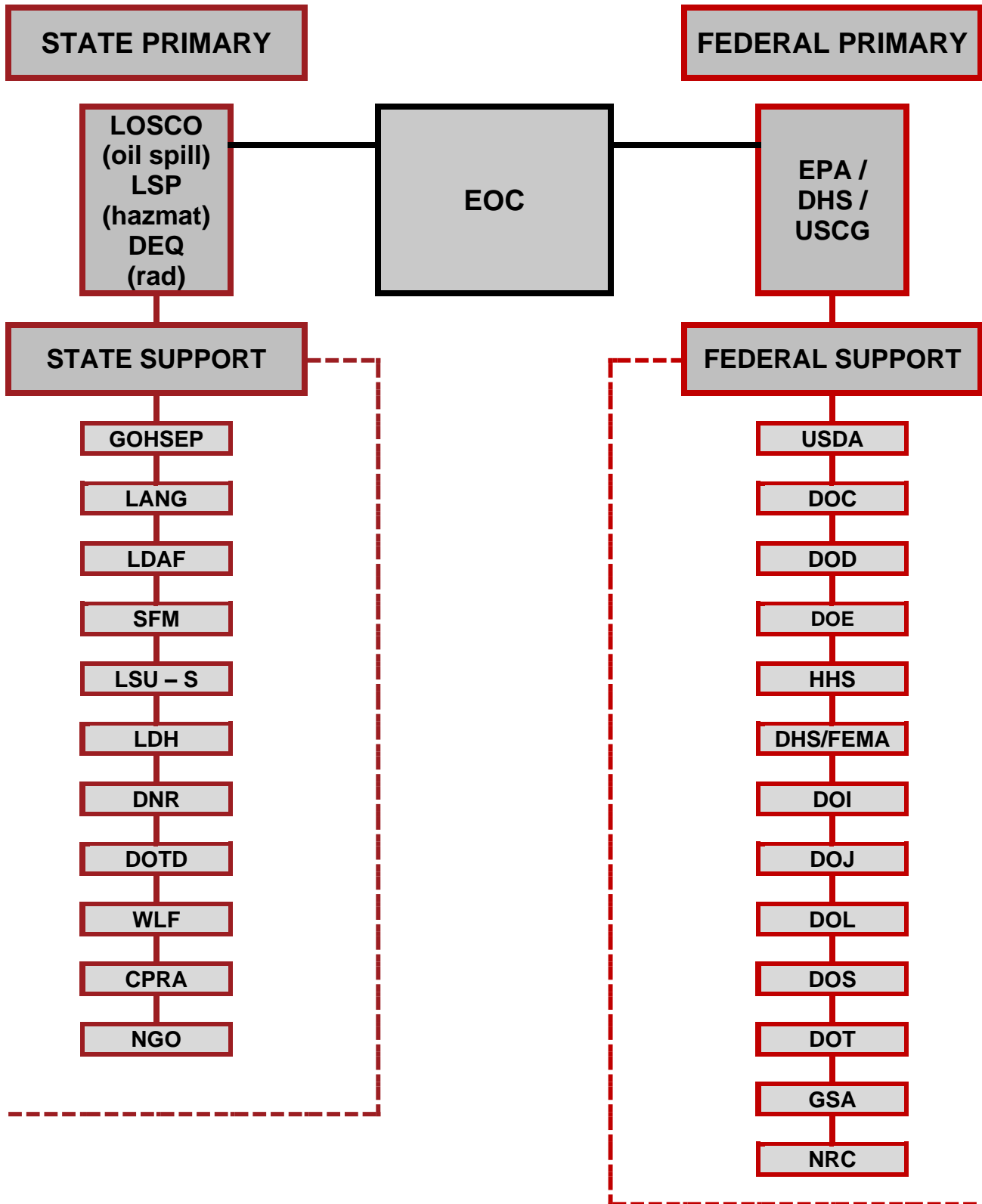

## **EMERGENCY SUPPORT FUNCTION 11 AGRICULTURE ANNEX**

### **I. PURPOSE**

This Annex outlines how LDAF will initiate a state response to an emergency or disaster affecting agriculture, food, household pets, nutritional assistance, or emergency fuel supply when local resources have been exhausted and a request for assistance has been made from a parish's Office of Homeland Security and Emergency Preparedness (OHSEP) to the Governor's Office of Homeland Security and Emergency Preparedness (GOHSEP).

### **II. SCOPE**

ESF-11 of Louisiana's SEOP identifies roles and responsibilities of agencies and groups that have committed their support to LDAF in protecting Louisiana's agriculture and food. This plan provides the framework for how these collaborations will work to integrate federal, state and local responders to achieve the desired results of a rapid and efficient response to a food, animal or agricultural emergency or disaster in the state. LDAF will accomplish its mission to deliver bulk fuel for emergency responders. All ESF-11 functions fall under the authority of the LDAF Emergency Programs Director.

### **III. CONCEPT OF OPERATIONS**

The Department of Agriculture and Forestry has the Primary Responsibility for Agriculture related emergencies and disasters.

#### **A. MITIGATION:**

The Commissioner of Agriculture will designate an LDAF Emergency Programs Director to organize and administer the ESF.

#### **B. PREPAREDNESS:**

1. The LDAF Emergency Programs Director will develop plans, procedures, arrangements and agreements to identify, acquire and mobilize agricultural, nutritional, animal related resources, and emergency fuel for emergencies and disasters.
2. The LDAF Emergency Programs Director will develop and maintain information and liaison with first responders to agriculture, nutritional, animal related resources, and emergency fuel in local, parish, state government, federal government, private industry and Non-Governmental Organizations (NGO) that could furnish assistance in an emergency or disaster.
3. The LDAF Emergency Programs Director or his designee will coordinate the delivery of fuel as well as necessary storage and dispensing resources to ensure a timely response to an emergency or disaster.
4. LDAF Emergency Programs Director will assist animal planning authorities in each parish in developing plans for evacuation, transportation, and sheltering of service animals and household pets.

#### **C. RESPONSE:**

1. All LDAF activities conducted under this Base Plan or any of the associated Incident Annexes will be conducted under ICS and will be consistent with NIMS. Incidents involving multiple agencies will coordinate through the SEOC in a MAC System. LDAF's personnel serving at GOHSEP will be stationed in the SEOC and onsite management of the incident will be run out of the LDAF ICP by the IC or UC in a situation where there are two lead agencies in a response.
2. For any type of state response to an agriculture, food or animal emergency or disaster, this Plan will be followed. An incident occurs when state response to an agriculture, food or animal emergency is requested by a parish or otherwise dictated by a state or federal agency. This Plan can be activated several ways. A parish OHSEP may exhaust local resources responding to a food, animal or agriculture emergency or disaster and request LDAF support directly from LDAF or through the ESF-11 Desk Officer at the SEOC, if ESF-11 has been activated. Any request for LDAF support or response will be channeled to the Commissioner of Agriculture and Forestry and who in most cases will delegate response authority to the LDAF Director of Emergency Programs or Incident Commander.
3. LDAF Emergency Programs Director will maintain visibility on USDA food programs and collaborate with ESF-6 as necessary to support the needs of events.
4. When mass evacuations occur, the LDAF Emergency Programs Director will work with animal planning authorities in each parish to arrange for the humane evacuation, transport, and temporary sheltering of service animals and household pets that need assistance.
5. The LDAF Emergency Programs Director or his designee will coordinate the delivery of fuel as well as necessary storage and dispensing resources to ensure a timely response to an emergency or disaster.

#### D. RECOVERY:

Recovery following a food or agriculture incident is key to ensuring that there is a continued market for goods. LDAF and other state and federal entities will begin planning incident recovery at the initial response. This planning will attempt to restore commercial operations to normal as rapidly as possible to lessen the impact on citizens, the food supply and the economy.

#### IV. ORGANIZATION AND RESPONSIBILITIES

- A. The Department of Agriculture and Forestry has the primary responsibility for providing and coordinating nutritional and plant and animal health and sufficiency.
- B. The following agencies, departments and organizations have been identified as having a potential role in an ESF -11 response. Specific roles and responsibilities are identified in the specific Incident Annexes to the Plan.
  1. Louisiana National Guard
  2. Department of Corrections
  3. Department of Environmental Quality
  4. Louisiana Department of Health
  5. Louisiana Board of Regents



6. Louisiana State University System
7. Department of Wildlife and Fisheries
8. Governor's Office of Homeland Security and Emergency Preparedness
9. Department of Children and Family Services
10. Southern University and Ag Center
11. Non-Governmental Organizations (NGO)
12. United States Department of Agriculture
  - a. Animal Plant Health Inspection Service (APHIS)
    - i. Veterinary Service (VS)
    - ii. Plant Protection and Quarantine (PPQ)
    - iii. Animal Care (AC)
    - iv. Wildlife Services (WS)
  - b. Farm Services Administration (FSA)
  - c. Natural Resources Conservation Service (NRCS)
  - d. USDA Office of Homeland Security
13. Department of Transportation and Development

## **V. COMMAND AND CONTROL**

NIMS-ICS command and control will be exercised as provided in the Basic Plan.

## **VI. CONTINUITY OF GOVERNMENT**

Continuity of government will be as provided in the Basic Plan.

LDAF has a continuity of operations plan (COOP) as an Annex to this Plan. The COOP identifies critical services LDAF must continue even in the event of a natural or manmade disaster, and the steps necessary to maintain these critical services. In addition, the COOP identifies orders of succession for leadership and authority within LDAF.

## **VII. ADMINISTRATION AND LOGISTICS**

- A. If State resources are inadequate to the tasks assigned, the ESF 11 IC/UC will inform the LDAF Emergency Programs Director who will then report the situation and the needs to GOHSEP, which will seek additional resources from EMAC (LRS 29:733) and from the federal government pursuant to a Presidential Disaster Declaration.
- B. Every agency providing agricultural support will maintain records of the operations, including cost records that can be used after the emergency to obtain reimbursement from state or federal sources.

## **VIII. PLAN MAINTENANCE**

The review and update of this Base Plan and its Incident Annexes is the responsibility of the LDAF Director of Emergency Programs. All Plan reviews and updates will be conducted in coordination with state, federal and private sector stakeholders.

## **IX. AUTHORITIES AND REFERENCES**

Authorities and references are included in the Basic Plan.

## **X. APPENDICES**

- A. ESF 11 Responsibility Chart
- B. ESF 11 State-Federal Crosswalk
- C. Response Chart
- D. Plans on File at LDAF
  - 1. Natural Disasters
    - a. Agriculture Planning, Response, and Assessment
    - b. Pet Evacuation, Transportation, and Sheltering
    - c. Emergency Fuel
  - 2. Foreign and Emerging Animal Diseases
    - a. Poultry (HPAI/LPAI)
    - b. Livestock (FMD)
    - c. NVS Logistics Plan
  - 3. Crop Protection
    - a. Exotic Plants and Bioterrorism
    - b. Damaging Pest and Diseases
  - 4. Food Supply
  - 5. Manmade Disasters
  - 6. Continuity of Operations

**APPENDIX 1 – ESF 11  
AGRICULTURE RESPONSIBILITY CHART**

<b>Agency support to the Louisiana Department of Agriculture and Forestry</b>	<b>Food Safety</b>	<b>Animal Health</b>	<b>Animal Evacuation &amp; Sheltering</b>	<b>Animal Disease Detection and Control</b>	<b>Food Supply</b>	<b>Pet Transportation Contract Support</b>	<b>Emergency Fuel Supply</b>
Louisiana National Guard							X
Department of Corrections			X				
Department of Environmental Quality	X			X			
Louisiana Department of Health	X			X			
Louisiana Board of Regents	X	X	X	X	X		
Louisiana State University System	X	X	X	X	X		
Department of Wildlife and Fisheries	X	X	X	X			
Governor’s Office of Homeland Security and Emergency Preparedness			X			X	X
Department of Children and Family Services			X				
Southern University System and Ag Center	X	X	X	X	X		
Non-Governmental Organizations (NGO) *	X	X	X	X	X		
Department of Transportation and Development						X	X
<b>*To include private relief organizations (i.e. American Red Cross, Salvation Army, Mennonite Disaster Service, etc.); private industry; professional associations and participants in mutual aid agreements, etc.</b>							

**APPENDIX 2 – ESF 11  
AGRICULTURE STATE – FEDERAL CROSSWALK**

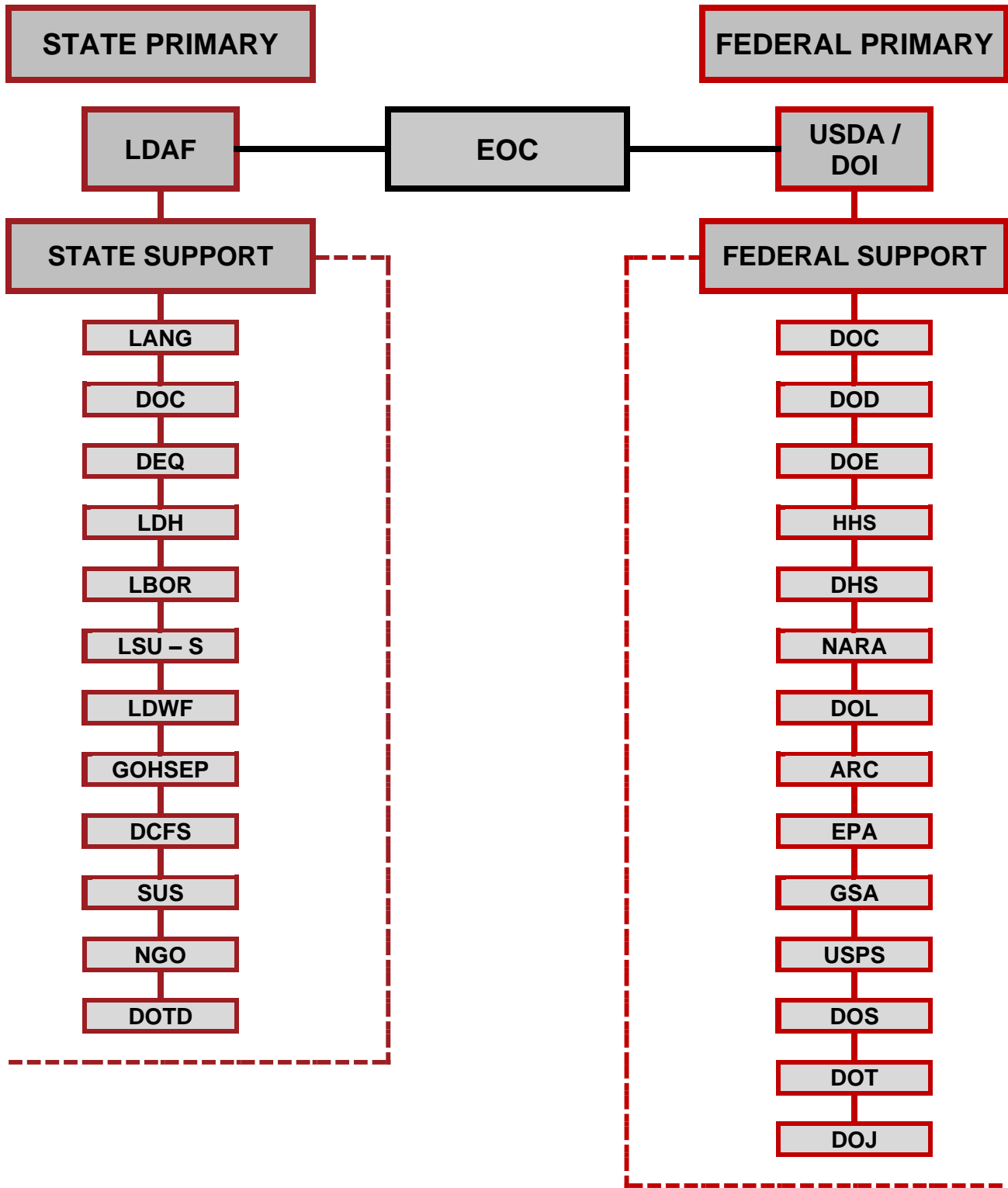

## **EMERGENCY SUPPORT FUNCTION 12 ENERGY AND UTILITIES ANNEX**

### **I. PURPOSE**

ESF 12 outlines detailed implementing procedures for all primary functions associated with the maintenance and restoration of natural gas and electric utility service; oil and natural gas production and transportation during and after a disaster, provision of fuel for emergency services and the public, and water and wastewater utilities. It includes the roles and responsibilities of the primary responsible agencies, the Louisiana Public Service Commission (LPSC), the Louisiana Department of Natural Resources (LDNR), and the Louisiana Department of Health (LDH), and that of support agencies including, but not limited to, the Louisiana Department of Agriculture and Forestry (LDAF), the Louisiana Water/Wastewater Agency Response Network (LaWARN), and the Louisiana Department of Environmental Quality (LDEQ).

### **II. SCOPE**

State services under this ESF include and encompass the restoration of natural gas, electric utilities, water and wastewater utilities, oil and natural gas production and transportation – subject to interruption or destruction by emergencies and disasters and providing fuel during and immediately following the disaster until such time as normal fuel supply processes are restored. This ESF covers procedures for all phases of emergency management; including pre-disaster preparation and post-disaster responsibilities.

### **III. CONCEPT OF OPERATIONS**

ESF 12 has three primary responsible agencies. The Department of Natural Resources is responsible for the coordination of the supply of intrastate natural gas and the gathering and reporting of information about oil and gas production in State waters in the Gulf of Mexico. The Public Service Commission is responsible for the regulation and restoration of private natural gas and electrical utilities. The Louisiana Department of Health is responsible for the regulation and restoration of public water systems and provides assistance with the assessment and restoration of wastewater utilities in the State of Louisiana.

#### **A. MITIGATION:**

The Secretary of the Department of Natural Resources (DNR), the Executive Secretary of the Public Service Commission (LAPSC), and the Secretary of the Louisiana Department of Health (LDH) will designate Coordinators for ESF 12, Energy and Utilities.

#### **B. PREPAREDNESS:**

1. The DNR Coordinator will develop and maintain information about and liaison with offshore petroleum and natural gas producers and intrastate natural gas producers and distributors.
  - a. The coordinator will maintain access to the oil and gas applications of the Strategic Online Natural Resources Information System 2000 (SONRIS2000)
    - i. Give location of oil and gas activity including owner and operator contacts; GIS system

- ii. Conduct an annual check on the system housed at GOHSEP (include in preparedness) and also as needed
    - iii. Conduct annual training for people using the system on or before June 1 and also as needed
  - b. Maintain a database of contacts which is updated annually (see page 15 of DNR Administrative Policy 11)
  - c. Maintain staff experienced in oil and gas emergency preparedness matters through coordination with MMS, Louisiana Mid-Continental Oil and Gas and other producers to gain an understanding on information and needs preparatory prior to landfall (see annex C.1); include liaison
  - d. Participate and plan in training exercises with GOHSEP as needed
2. The LPSC Coordinator will assist in the development of plans, procedures, arrangements and agreements to identify jurisdictional electric and natural gas distribution utility impairments resulting from emergencies and disasters and assist in the acquisition, mobilization and employment of resources to restore service to affected customers.
- a. Maintain electric and natural gas distribution utility emergency operating and service restoration plans
  - b. Establish a database for electric and natural gas distribution utilities to report outages, and establish reporting procedures during emergencies.
  - c. Assist GOHSEP with identifying critical infrastructure needs with respect to the restoration of utility services
  - d. Participate and plan in training exercises with GOHSEP as needed
  - e. Annual meeting with utilities prior to hurricane season
  - f. Update utilities' emergency contact lists prior to hurricane season
  - g. Maintain a crew of staff that are trained in operating the outage database and who are able to respond to activation of the State EOC by GOHSEP.
3. The Louisiana Department of Health (LDH) Coordinator will establish procedures for the use and quality of drinking water supplies used during and after an emergency. The LDH Coordinator will establish procedures to assess damage to water utilities, issue water use advisories, and direct assessment and restoration activities for water utilities. The LDH Coordinator will work with the DEQ Coordinator in planning for the assessment and restoration of wastewater utilities and for the use of temporary discharge, storage, conveyance and treatment facilities for domestic wastewater.
- a. Maintain standard operating procedures for the assessment and operational status of public water systems
  - b. Keep all necessary software and databases used to conduct emergency response operations up to date and continually train staff on the utilization

- I. Safe Drinking Water Information System (SDWIS)
  - II. Louisiana Drinking Water Watch
  - III. EPA Response Manager
- c. Assist GOHSEP to identify critical infrastructure needs with respect to the restoration of utility services
  - d. Participate and plan in training exercise with GOHSEP as needed
  - e. Annual meeting with GOHSEP prior to hurricane season
  - f. Maintain experienced staff with the proper training to conduct all required emergency response/recovery operations including field assessments and operation of the ESF 12 – LDH desk.

C. RESPONSE:

1. As DNR becomes aware of an emergency that could cause an interruption of petroleum or natural gas production in offshore areas, such as an approaching tropical system, the ESF 12 Coordinator will gather and report information on the extent of production reduction such information will be gathered in accordance with procedures established by DNR Administrative Policy 11.
2. The DNR ESF 12 Coordinator will compile and report information on the location and capacities of natural gas transmission and distribution pipeline systems.
3. The DNR ESF 12 Coordinator will convey the state's assessed needs and requirements for natural gas services to intrastate natural gas transporters in order to provide service when and where it is needed for as long as emergency conditions exist. Priorities for the allocation of natural gas in the restoration of emergency utilities will be assigned by the Commissioner of Conservation and will be coordinated with public and private natural gas distribution companies. Restoration of services to priority customers, such as public safety, hospitals, nursing homes and single family residences will be given first priority.
4. The LPSC ESF 12 Coordinator will compile reports from the outage reporting database regarding the number of service outages and the expected date and time of restoration. These reports will be tailored to convey the information needed most by GOHSEP and other State agencies, i.e. Electric Outages by Parish, Electric Outages by Utility, etc.
5. The LPSC Coordinator will provide electric and natural gas distribution utility service outage reports to GOHSEP during emergencies, and will assist GOHSEP in identifying and prioritizing the allocation of State resources in the restoration of utility services.
6. The LPSC Coordinator will relay information from GOHSEP and other State agencies to the utility companies concerning priority restoration for locations identified by the utilities and GOHSEP as critical to saving life and property, and to overall recovery of an area.
7. The LPSC Coordinator will assist GOHSEP with the coordination and allocation of emergency power generation equipment made available by local governments, state agencies, the federal government and private organizations through the procedures established by GOHSEP.

8. The Louisiana Department of Health (LDH) Coordinator will manage the reporting of public water system operability assessments, drinking water advisories, and other drinking water reports/maps as required.
9. The LDH Coordinator will provide boil advisory and water infrastructure damage reports to GOHSEP, federal and local governmental entities during emergencies.
10. The LDH Coordinator will assist the DEQ Coordinator as needed with the assessment and restoration of wastewater utilities.
11. The LDH Coordinator will assist other State agencies or local government entities as requested in the coordination and distribution of bulk water or other necessary supplies to public water systems in affected utility service areas.

#### D. RECOVERY:

The ESF 12 Coordinators from DNR, LAPSC, and LDH/OPH will continue to monitor the progress of rebuilding and restoring utility capacity and service in their respective areas of jurisdiction and responsibility and report on such progress.

1. DNR will track all natural gas reduction and production by putting out a daily report through SONRIS system, emails, and phone calls as needed
2. LPSC will track electric and natural gas distribution utility service outages and report them to GOHSEP until restoration efforts are complete or until otherwise directed by GOHSEP.
3. LDH will continually track water service outages and issue public water system advisory reports regarding drinking water quality and report them to GOHSEP and federal/local governmental entities until restoration efforts are complete. LDH will authorize additional laboratory services (either contractual or donated) as needed for drinking water analyses. DEQ may authorize additional laboratory services (either contractual or donated as needed for wastewater discharge analyses.
4. The Louisiana National Guard will provide infrastructure protection as assets are available and missions are assigned in accordance with existing plans, including mobile electrical generation units

#### IV. ORGANIZATION AND RESPONSIBILITIES

- A. The Department of Natural Resources has the primary responsibility for the portions of the Energy and Utilities ESF 12 that relate to intrastate natural gas and the gathering and reporting of information about the offshore production of petroleum and natural gas.
- B. The Louisiana Public Service Commission has the primary responsibility for the portions of the Energy and Utilities ESF 12 that relate to the regulation and coordination of electric power and natural gas supply systems.
- C. The Louisiana Department of Health has the primary responsibility for the portion of Energy and Utilities ESF 12 that relate to the regulation and coordination of public drinking water systems. In addition, LDH will assist LDEQ with oversight and assessment of wastewater systems.
- D. The support agencies for Energy and Utilities operations are responsible for developing and maintaining plans, procedures and asset inventories to support the ESF 12 Coordinators. Support Agencies include, but are not limited to:



1. Louisiana Department of Environmental Quality (Wastewater Utilities)
2. Department of Agriculture & Forestry
3. Non-Governmental Organizations (NGO)
4. Louisiana National Guard
5. Louisiana Rural Water Association
6. Louisiana Water/Wastewater Agency Response Network

**V. COMMAND AND CONTROL**

Command and control will be exercised as provided in the Basic Plan.

**VI. CONTINUITY OF GOVERNMENT**

Continuity of government will be as provided in the Basic Plan.

**VII. ADMINISTRATION AND LOGISTICS**

- A. If State and in-state resources are inadequate to the tasks assigned, the ESF 12 Coordinators will report the situation and the needs to GOHSEP, which will seek additional resources from EMAC (LRS 29:733) and from the federal government pursuant to a Presidential Disaster Declaration.
- B. Every agency providing emergency energy and utilities support will maintain records of the operations, including cost records that can be used after the emergency to obtain reimbursement from state or federal sources.

**VIII. PLAN MAINTENANCE**

The ESF 12 Energy and Utilities Coordinators are responsible for developing, maintaining and coordinating plans, procedures, arrangements and agreements in support of this ESF.

**IX. AUTHORITIES AND REFERENCES**

Authorities and references are included in the Basic Plan.

## **X. APPENDICES**

1. ESF 12 Responsibility Chart
2. State-Federal Crosswalk

**APPENDIX 1 – ESF 12  
ENERGY AND UTILITIES RESPONSIBILITY CHART**

Agency support to the Louisiana Department of Natural Resources, Louisiana Department of Health, and the Louisiana Public Service Commission	Fuel Equipment & Personnel	Transportation – Land	Power Generators	Construction & Repairs	Damage Assessment	Operate and Perform Analyses	Permit Use (Water and Wastewater)
LAWARN (Wastewater Utilities)	X		X	X	X	X	
Department of Agriculture and Forestry	X	X			X		
Non-Governmental Organizations (NGO)*					X		
Louisiana National Guard		X					
Department of Environmental Quality					X		X
Louisiana Rural Water Association	X		X		X	X	
*To include private relief organizations (i.e. American Red Cross, Salvation Army, Mennonite Disaster Service, etc.); private industry; professional associations and participants in mutual aid agreements, etc.							

**APPENDIX 2 – ESF 12  
ENERGY AND UTILITIES ANNEX STATE – FEDERAL CROSSWALK**

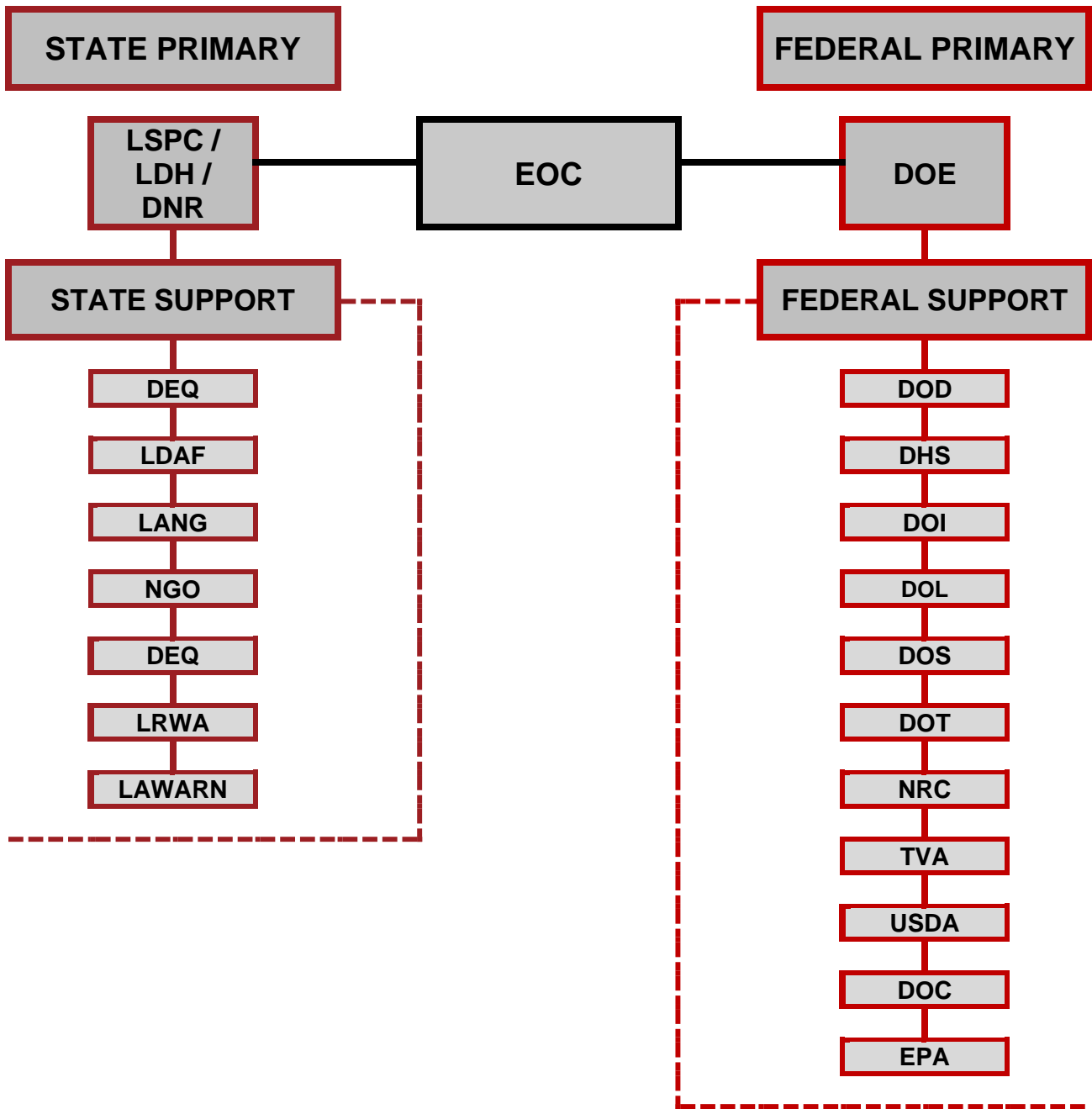

## **EMERGENCY SUPPORT FUNCTION 13 PUBLIC SAFETY AND SECURITY ANNEX**

### **I. PURPOSE**

ESF 13 provides for the provision of law enforcement, emergency police and public safety services and legal authority in an emergency or disaster.

### **II. SCOPE**

State services under this ESF shall include the identification, mobilization and coordination of available State government and other public safety and legal manpower, expertise and equipment to minimize the adverse impact of an emergency or disaster on life and property in the affected area. These actions taken before, during and after such an occurrence, and in cooperation with appropriate jurisdiction authorities, shall assure the continuity of law enforcement and public safety during periods of disasters, mitigation and recovery.

### **III. CONCEPT OF OPERATIONS**

The Public Safety and Security ESF 13 includes actions taken to provide for the protection of the state's citizens and visitors during an emergency or disaster and ensures that those actions conform to applicable state law, rules and regulations. ESF 13 has two primary responsible agencies: the Louisiana State Police (LSP) and the Department of Justice (DOJ). The Louisiana Department of Wildlife and Fisheries (LLDWF) will serve as the lead state agency for all port and maritime public safety and security issues, and will coordinate with the Louisiana State Police on maritime ESF-13 operations as part of the overall ESF-13 mission.

#### **A. MITIGATION:**

The protection of the public requires the timely and coordinated efforts of all law enforcement personnel. The LSP Superintendent and the Attorney General will designate Coordinators for ESF 13. These designees will be responsible for the coordination of the agencies and assets necessary to carry out the responsibilities outlined in ESF 13 of this annex and in Supplement 6, the ESF support plan.

#### **B. PREPAREDNESS:**

1. The DOJ will review existing legislation, rules and regulations to ensure that the authorities will be able to take action to protect people and property in emergencies and disasters and recommend corrective legislation as appropriate.
2. The DOJ Coordinator will ensure that actions are taken in accordance with the legal authority of the state and that persons acting in good faith to protect people and property are not penalized or subjected to liability.
3. The DOJ will prepare detailed implementing procedures for all primary functions, including procedures by which the office will be alerted and activated for 24-hour operations if needed.
4. The DOJ will prepare requirements for supporting departments, agencies and offices and initiated coordination with supporting departments to ensure that they are aware of their roles and prepared to take necessary actions.

5. The LSP ESF 13 Emergency Coordinator will develop detailed plans, procedures, arrangements and agreements for all primary functions, to include the procedures by which the office will be alerted and activated for 24-hour operations if needed.
6. The LSP ESF 13 Coordinator will prepare requirements for supporting departments, agencies and offices and initiate coordination with supporting departments to ensure they are aware of their roles and prepared to take necessary action.
7. The LSP ESF 13 Coordinator will develop plans, procedures, arrangements and agreements to mobilize law enforcement personnel and equipment to provide the maximum level of public safety and security.
8. Both ESF 13 Coordinators will initiate contacts and liaisons with supporting state agencies and local and federal authorities to ensure productive working relationships.
9. In some cases law enforcement authorities may have advance notice of a potential emergency, such as a terrorist or criminal act, or a slow-moving hurricane or severe weather system. In such cases law enforcement authorities may be able to pre-position some of their forces in order to prevent and/or apprehend the persons attempting to commit an act, expedite evacuations and limit the potential injuries and damages that could result from the act or storm.
10. The LSP Coordinator will initiate contacts as needed with federal law enforcement authorities in order to anticipate law enforcement and public safety threats and problems. The coordinator may arrange for the setup of a Joint Operation Center with federal authorities.
11. The Louisiana Department of Wildlife and Fisheries will coordinate with local and federal counterparts regarding port and maritime emergency preparedness, to include detailed emergency response planning and security coordination with members of the maritime industry.

#### C. RESPONSE:

1. Based on the type of emergency situation, the ESF Coordinators will activate all the personnel and equipment resources required. In addition, ESF Coordinators should alert reserve and auxiliary resources to monitor the emergency situation and prepare for activation as well.
2. When appropriate, response efforts will be in accordance with the National Incident Management System guidelines and recommendations.
3. The LSP Coordinator will relay requests for additional support to GOHSEP as the needs become apparent, and deploy the resources as they become available.
4. The Justice Department will issue expedited opinions as the emergency or disaster progresses and legal questions come up.
5. The LSP Public Safety Coordinator may set up a Law Enforcement Operations Center or Command Post as required by the situation. The LSP Coordinator will initiate liaison with federal law enforcement authorities to ensure that public safety operations are organized and cooperative. Representatives from the Louisiana Sheriff's Association (LSA), the Louisiana Association of Chiefs of Police (LACP), and the Joint Terrorism Task Force,

regional, local and parish law enforcement agencies and out-of-state and federal law enforcement agencies may be included as conditions merit.

6. Private security agencies, auxiliary police or volunteers will only be used if they are sworn in.
7. Support to the sheriffs and chiefs of police will be in accordance with the agreements set forth in Mutual Aid Agreements.
8. The Department of Wildlife and Fisheries, functioning as the lead state agency on port and maritime security issues, will be forwarded requests related to maritime law enforcement and security by the Louisiana State Police.

**D. RECOVERY:**

Law enforcement and public safety operations will be continued as long as necessary after the conclusion of the emergency or disaster. Particular attention will be paid to securing the disaster area from looting and criminal mischief and controlling the orderly re-entry of evacuees.

**IV. ORGANIZATION AND RESPONSIBILITIES**

- A. The LSP has the Primary Responsibility for Public Safety and Security operations.
- B. The Attorney General has the Primary Responsibility for validating the legal authority for Public Safety and Security operations.
- C. The support agencies for Public Safety and Security operations are responsible for developing and maintaining plans, procedures and asset inventories to support the ESF 13 Coordinators. Support agencies include, but are not limited to:
  1. Louisiana National Guard
  2. Department of Agriculture and Forestry
  3. Department of Corrections
  4. Department of Culture, Recreation and Tourism
  5. Department of Revenue – Office of Alcohol and Tobacco Control
  6. Department of Transportation and Development
  7. Department of Wildlife and Fisheries
  8. Office of Juvenile Justice
  9. Office of the Lieutenant Governor
  10. Office of State Fire Marshal

**V. COMMAND AND CONTROL**

Command and control will be exercised as provided in the Basic Plan.

**VI. CONTINUITY OF GOVERNMENT**

Continuity of government will be as provided in the Basic Plan.

## **VII. ADMINISTRATION AND LOGISTICS**

- A. If state public safety and security resources are inadequate to the tasks assigned, the ESF 13 Coordinators will report the situation to GOHSEP, which will seek additional resources from EMAC and from the federal government pursuant to a Presidential disaster Declaration.
- B. Every agency providing emergency public safety and security support will maintain records of the operations, including cost records that can be used after the emergency to obtain reimbursement from state or federal sources.

## **VIII. PLAN MAINTENANCE**

The ESF 13 Public Safety and Security Coordinators are responsible for developing, maintaining and coordinating plans, procedures, arrangements and agreements in support of this ESF.

## **IX. AUTHORITIES AND REFERENCES**

Authorities and references are included in the Basic Plan.

## **X. APPENDICES**

- A. ESF 13 Responsibility Chart
- B. State-Federal Crosswalk



**APPENDIX 1 – ESF 13  
PUBLIC SAFETY AND SECURITY RESPONSIBILITY CHART**

<b>Agency support to the Louisiana Department of Justice and the Louisiana State Police</b>	<b>Law Enforcement</b>	<b>Detention – Facilities</b>	<b>Detention – Transportation</b>	<b>Traffic Routing &amp; Control</b>	<b>Control Access to Assigned</b>	<b>Courier Service</b>	<b>Communications – Equipment</b>	<b>Communications – Repair</b>	<b>Transportation – Air</b>	<b>Transportation – Water</b>	<b>Transportation – Land</b>	<b>Vehicle Repair Facilities</b>	<b>Legal Research and Analysis</b>	<b>Escorts</b>
Louisiana National Guard	X			X	X		X		X		X			X
Department of Agriculture and Forestry	X			X	X	X	X		X	X	X			
Department of Corrections	X	X	X	X	X		X				X			
Department of Culture, Recreation and Tourism	X			X	X		X			X				X
Department of Revenue – Office of Alcohol and Tobacco Control	X													
Department of Transportation and Development			X	X	X	X	X			X	X	X		X
Department of Wildlife and Fisheries	X			X	X	X	X			X	X			
Office of Juvenile Justice	X	X		X	X		X					X		
Office of the Lieutenant Governor	X			X	X		X			X				X
Office of State Fire Marshal	X			X	X	X	X			X	X			X

**APPENDIX 2 – ESF 13  
PUBLIC SAFETY AND SECURITY STATE – FEDERAL CROSSWALK**

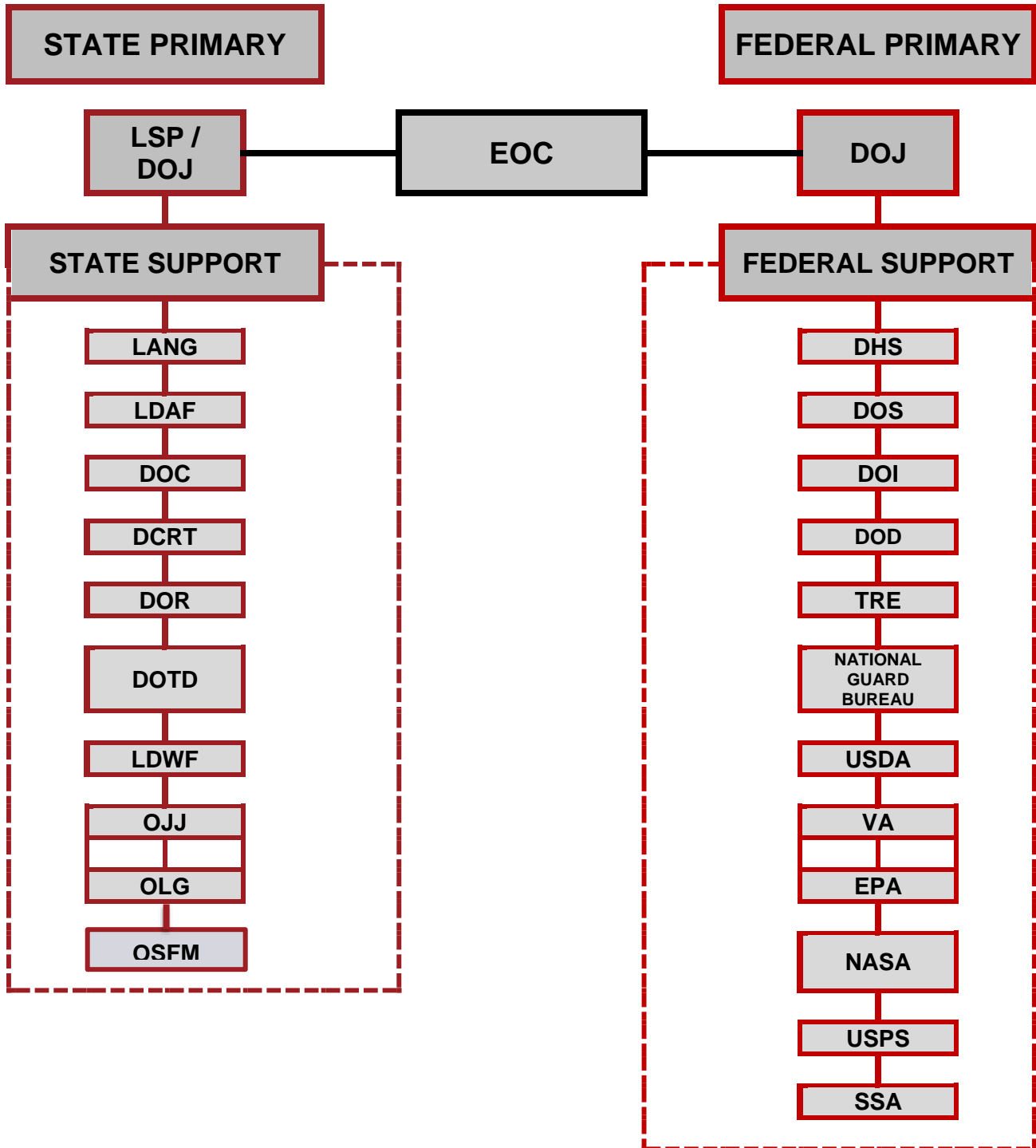

## **EMERGENCY SUPPORT FUNCTION 14**

### **STATE OF LOUISIANA DISASTER RECOVERY FRAMEWORK**

#### **I. PURPOSE**

The purpose of this document is to utilize the State of Louisiana Disaster Recovery Framework (SLDRF) in conjunction with the National Disaster Recovery Framework (NDRF) to provide guidance to respective state agencies regarding recovery operations and responsibilities. The SLDRF defines an approach that the state of Louisiana will use to support local communities in recovery. Each community has unique needs and resources and they are amplified at the time a disaster strikes. The state has the ability to prioritize and prepare for the inevitable disaster event that will threaten lives and compromise the ability the community has to take action. The preparation and planning will take a comprehensive look at the disaster circumstances and align Recovery Support Functions (RSF's) to carry out missions when life and safety are no longer threatened. The RSF's are assigned to state agencies that have been identified as having the personnel, equipment, and resources necessary to effectively support the state of Louisiana during disaster recovery.

#### **II. SCOPE**

Disaster assistance programs made available after Gubernatorial Proclamations and Presidential Disaster Declarations are implemented in accordance with provisions of the Robert T. Stafford Disaster Relief Act and Emergency Assistance Act, P.L. 93-288 as amended, the Disaster Mitigation Act of 2000, the Post Katrina Emergency Management Reform Act of 2006, Federal Emergency Management Agency (FEMA) regulations, the National Disaster Recovery Framework (NDRF), the State of Louisiana's Disaster Recovery Framework (SLDRF (ESF 14)), the State of Louisiana Administrative Plan for Federal Public Assistance and Federal Fire Management Assistance, and the State's administration of Federal Disaster Assistance Programs such as; The Individuals and Households Program (IHP), the Small Business Administration (SBA) Disaster Loan Program, the Public Assistance Program, and the State Hazard Mitigation Grant Program (SHMP).

In order to transition the State from response to recovery the leading RSF's will stand up ESF 14 State of Louisiana Disaster Recovery Framework (SLDRF). The decisions in short term and intermediate recovery directly impact the long term recovery process. Agencies, roles and responsibilities, and functions in the SLDRF are applicable to each supporting RSF Annex. The State of Louisiana RSF Annexes build upon the short term, intermediate and long term recovery core capabilities, and further define applicable state led strategies.

#### **III. LEADERSHIP**

Leadership is needed to ensure that the inclusive process that RSFs will use to aid local communities is realistic, well planned, and clearly communicated vertically and horizontally with stakeholders, partners, and the public. Leadership must instill confidence that recovery goals can be achieved.

The Long Term Recovery Subcommittee (LTRS) was created pursuant to Louisiana Revised Statute 29:725.6(d)(i) . GOHSEP and the Office of Community Development (OCD) co-chair the LTRS. Its primary purpose is to develop long-term recovery planning and to advise on opportunities that will achieve sustainability efforts within affected localities. It will also establish advisory subcommittees for specific issues.

The LTRS is the executive steering committee for the RSFs. The LTRS will be convened by the Unified Command Group upon transition from response to recovery and when incidents have stabilized. The LTRS will receive a briefing from the Unified Command Group on the status of

emergency operations and the turnover to RSF's. GOHSEP Emergency Management (ESF-5) will facilitate a Recovery Taskforce call with affected parishes and/or municipalities and their leadership. The call will focus on recovery action items; including, but not limited to: community and business focused outreach, reports from parishes and or municipalities on ongoing operations, infrastructure security and restoration, Multi-Agency Shelter Transition (MASTT) operations, and unmet needs identified from leadership. The LTRS will appoint an event specific State Disaster Recovery Coordinator (SDRC) and activate RSFs to address reports and unmet needs. The SDRC will direct recovery activities from such RSF's as may be appropriate.

Louisiana Housing Corporation (LHC), with supported resources identified from The Louisiana Disaster Housing Taskforce (LDHTF) is the Housing Recovery Support Function - RSF-4 (state –led) resource for dynamic housing solutions for survivors. The LDHTF is comprised of membership from Louisiana Housing Corporation (LHC), Louisiana Housing Authority (LHA), GOHSEP, OCD, and the Department of Children and Family Services (DCFS). The LDHTF has applicable stakeholders in housing at the local (both non-governmental and governmental), and the federal level. The LDHTF supports resource development for disaster specific State housing priorities. The LDHTF members are a part of state agencies that have pertinent leadership roles in emergency management, housing, health and social services, case management, and mass care; all of these roles significantly influence individual and community recovery.

The LDHTF will be activated by the LTRS in conjunction with survivor centric needs; in which the State can articulate during environmental stabilization. In the event of shelter operations overwhelming the capacity of the local OHSEP well into intermediate recovery, the State will implement the MASTT team. The LDHTF, with its available resources, will function as the State MASTT team and will support moving affected survivors from mass care sheltering to the most stable or permanent housing solution, whenever possible.

#### **IV. CONCEPT OF OPERATIONS**

##### **A. Preparedness (Ongoing)**

1. The LTRS and its advisory committees will lead the Statewide pre-disaster recovery and risk assessment planning efforts
2. The LTRS and its advisory committees will identify recovery activities that are either the responsibility of State government or beyond the capability of local government
3. The LTRS and its advisory committees will provide technical assistance and training on state plans, programs and other resources for disaster recovery
4. The LTRS and its advisory committees will create and train strategies to State personnel that coincide with relevant legislative authorities and programs at the state and federal level to ensure staff members have the most up to date knowledge on the requirements and administration of programs, as well as, the best tools to advance individual and community recovery
5. The LTRS and its advisory committees will educate individuals and families on measures to prepare for their own recovery (prevention lists, safety measures, NGO's, communication networks, savings, adequate insurance, documentation, applicable funding streams), to the best extent possible
6. The LTRS and its advisory committees will support local governments in the establishment of pre-disaster recovery leadership in the form of a Local Disaster

Recovery Manager (LDRM), and coordination structures that are inclusive of risk reduction and community preparedness

- i. The LTRS and its advisory committees will develop and participate in planning, training and exercises supported by the state and federal government in order to improve upon areas needing core capabilities
7. The LTRS and its advisory committees will identify non-governmental partners and solidify strategic partnerships with applicable contracts and/or Memoranda of Understanding (MOU's)

#### B. Short Term Recovery (Days)

1. The LTRS will appoint a State Disaster Recovery Coordinator (SDRC) to lead and coordinate recovery dedicated organizations, plans and initiatives
2. The SDRC will lead state agencies in the administration of programs, projects and plans from the State and Federal Government and designate outreach as appropriate
3. The progress of rebuilding and restoring utility capacity and service is in accordance with ESF 12
4. The Individual Assistance Grant Coordinator, provided by GOHSEP will be responsible for understanding the State's requirements in the Individual and Households Program; Preliminary Damage Assessment (PDA)'s, Housing Assistance and Other Needs Assistance Administrative Option Selection, administrative knowledge of the immediate/regular Crisis Counseling Program, National Flood Insurance Program (NFIP), Louisiana State Housing Strategy, Programmatic/administrative knowledge of SBA disaster loans, IRS disaster program, USDA food stamps/commodities disaster program, legal aid, Farm Services, and Administration on Aging Services.
5. The Public Assistance Grant Coordinator, provided by GOHSEP is responsible for coordination with the Public Assistance applicant from declaration to funding approval. The Public Assistance Grant Coordinator has a working knowledge of Project Worksheets (PW) preparation and validation, environmental and flood plain regulations, insurance requirements, Preliminary Damage Assessment (PDA)'s and Hazard Mitigation funding under Section 406 (Stafford Act). The Public Assistance Grant Coordinator will identify potential applicants for Public Assistance and maintain contacts with local and state officials. Post Declaration, direction, control and administration will transition into the current annual State's administrative plan for PA.
6. In conjunction with the Joint Information System (ESF 15) there will be a comprehensive messaging/PR/media plan so that survivors have adequate knowledge of recovery programs and resources

#### C. Intermediate Recovery (Weeks – Months)

1. In the event of shelter operations overwhelming the capacity of the local OHSEP well into intermediate recovery; The LDHTF will support shelter demobilization according to an assessment of survivors' needs, an assessment of survivors' case management to return to a whole state, access to interim and permanent housing programs, all in consideration of specific requests, rationale, and solution-oriented outcomes.
2. Holistically, The LDHTF will support accessible and affordable interim housing solutions through State identified resources and priorities.
3. The Individual Assistance Grant Coordinator will be responsible for the State's assessment in the affected communities. The Individual Assistance teams will be adjusted based upon the level of impact and ongoing operations at the local level.

State led Individual Assistance teams will support human needs, coordinate applicable information and resources needed to survivors, as well as the outreach within shelters and Disaster Recovery Centers (DRCs). Coordination of outreach and unmet needs will be reported to the LTRS and/ or the LDHTF.

4. The Health and Social Services (HSS) Field Coordinator provided by LDH/DCFS/DOE will be responsible to support the identification of critical areas of need within health and social services; including critical areas of need with people with disabilities and others with access and functional needs (PDWAFN), services provided to children in schools and childcare settings, and people with limited English proficiency (LEP). The HSS Field Coordinator will work with the State's health and social services providers to support affected individuals and communities receiving human welfare essential services, identify critical resources for unmet needs, as well as, assess impacts to transition to long term restoration efforts as identified in the Health and Social Services (HSS) Recovery Support Function (LA RSF 3) Annex
5. The Community Planning and Capacity Building Coordinator, provided by OCD will work with locally impacted governments and communities' to assess and address local resources and local recovery plan implementation in order to identify gaps and opportunities for capacity building
6. In accordance with the Louisiana Volunteerism and Donations Management Plan, applicable state agencies and stakeholders will support local governments in their oversight of volunteer and donations management

#### D. Long Term Recovery (Months – Years)

1. The LTRS and its advisory committees will utilize lessons learned and best practices to administer the continuity of the SLDRF, the advisory committees roles and responsibilities during the preparedness phase, and the associated RSF appendixes and annexes
2. The LTRS and its advisory committees will use education, incentives, and regulation to reduce community vulnerability to various hazards by fostering more resilient building standards and land use opportunities while complying to existing plans, such as the current State of Louisiana Hazard Mitigation Plan
3. The LDHTF will support elected permanent affordable housing solutions in consultation with State identified resources and priorities
4. The LDHTF will support any single and multi-family reconstruction and rehabilitation efforts employing resiliency methods in consultation with State identified resources and priorities

### V. ORGANIZATION AND RESPONSIBILITIES

- A. GOHSEP has primary responsibility for the implementation and administration of the SLDRF. GOHSEP and The Office of Community Development have the primary responsibility of steering the LTRS to facilitate long term recovery planning, advisory committees responsibilities, and creating advisory committees for specific issues in accordance with Louisiana Revised Statute 29:725.6(d)(i), and the Subcommittee Bylaws
- B. The Office of Community Development has the primary responsibility for the RSF 1: Community Planning and Capacity Building Recovery Support Function

#### **Mission:**

The Mission of RSF-1 is to coordinate capacity building expertise and support programs to assist local governments in restoring and improving their ability to provide governmental services and organize, plan, manage, and implement long-term community recovery activities and initiatives.

- C. Louisiana Economic Development with support from the Business Emergency Operation Center has the primary responsibility for the RSF 2: Economic and Business Recovery Support Function

**Mission:**

The Mission of RSF-2 is to integrate local, state and federal expertise to help communities' rebuild businesses and develop new economic opportunities, with the goal of creating sustainable, economically-viable communities.

- D. The Department of Children and Family Services, Louisiana Department of Health, and Louisiana Department of Education have the primary responsibility for the RSF-3 Health and Social Services Recovery Support Function.

**Mission:**

The Mission of RSF-3 is to assist locally led recovery efforts in the restoration of the public health (including behavioral health), healthcare and social services networks to promote the resilience, health and well - being of affected individuals and communities.

- E. Louisiana Housing Corporation, with resources available from the Louisiana Disaster Housing Taskforce, has the primary responsibility for the RSF 4: Housing Recovery Support Function

**Mission:**

The Mission of RSF-4 is to address pre-and post-disaster housing issues and coordinate and facilitate the delivery of State resources and activities to assist local and Tribal governments in the rehabilitation and reconstruction of destroyed and damaged housing, whenever feasible, and development of other new accessible, permanent housing options

- F. The Coastal Protection and Restoration Authority and the Department of Transportation and Development have the primary responsibility for the RSF 5: Infrastructures Systems Recovery Support Function

**Mission:**

The Mission of RSF-5 is to integrate the capability of the federal government to support states and communities to permanently restore, enhance, mitigate, and ensure the resilience and protection of infrastructure systems impacted by disasters.

- G. The Louisiana Department of Wildlife and Fisheries and the Coastal Protection and Restoration Authority have the primary responsibility for the RSF 6: Natural and Cultural Resources

**Mission:**

The Mission of RSF-6 is to integrate State assets and capabilities to help local and Tribal governments and communities address long-term environmental and cultural resource recovery needs after large-scale and catastrophic incidents.

- H. The support agencies for the RSF's are as follows:
- Louisiana Workforce Commission
  - Louisiana Emergency Management Disability and Aging Coalition (EMDAC)
  - Louisiana Department of Revenue
  - Public Service Commission
  - University of Louisiana at Lafayette/NIMSAT
  - Louisiana Business EOC
  - Louisiana State University/SDMI
  - Louisiana Sea Grant@ LSU
  - Office of Financial Institutions
  - Office of the Lieutenant Governor/Volunteer Louisiana
  - Louisiana Department of Insurance
  - Louisiana Department of Education
  - Louisiana Department of Transportation and Development
  - LSU/Southern Ag Center
  - Louisiana Department of Agriculture and Forestry
  - Louisiana Department of Environmental Quality
  - Louisiana Housing Corporation
  - Louisiana Housing Authority
  - Louisiana Department of Insurance
  - Louisiana local and state VOAD
  - Governor's Office of Disability Affairs
  - Governor's Office of Elderly Affairs

## **VI. COMMAND AND CONTROL**

Command and Control will be exercised as provided in the Basic Plan.

## **VII. CONTINUITY OF GOVERNMENT**

Continuity of government will be as provided in the Basic Plan.

## **VIII. ADMINISTRATION AND LOGISTICS**

- A. If local, parish and state resources are inadequate to the tasks assigned; the RSF Coordinators will seek additional resources from EMAC and from the federal government pursuant to a Presidential Disaster Declaration.

## **IX. PLAN MAINTENANCE**

GOHSEP coordinates the plan updating process and maintains the plan after receiving feedback and updates from partner agencies. The State will always aim to plan, train, and exercise in order to provide technical support and capacity building activities. The intent is to ensure stakeholders and partners are adequately equipped to understand their recovery roles and responsibilities, as well as, look for gaps within their capabilities. This plan is intended to be the State's long term capability building tool. Pre-disaster this plan will maintain clear lines of communication with local/municipal, state, and federal partners. Post-disaster this plan will be revised based upon progress and lessons learned from assessment needs of recovery and the activation of RSF's.



**X. AUTHORITIES AND REFERENCES**

Authorities and references are included in the Basic Plan.

**XI. APPENDICES**

A. ESF 14 Responsibility Chart

B. State-Federal Crosswalk

**APPENDIX 1 – ESF 14**  
**STATE OF LOUISIANA DISASTER RECOVERY FRAMEWORK RESPONSIBILITY CHART**

Agency support to the Governor’s Office of Homeland Security and Emergency Preparedness and Louisiana Economic Development	Authority / Policy	Coordination	Analysis	Community Action	Infrastructure	Coastal & Watershed
Louisiana Economic Development		X	X	X	X	
Department of Agriculture and Forestry			X		X	
Department of Culture, Recreation and Tourism		X			X	
Office of the Lieutenant Governor		X			X	
Department of Education			X	X		
Department of Environmental Quality			X		X	
Division of Administration	X	X	X			
Office of Financial Institutions	X	X	X			
Louisiana State University System				X	X	
Louisiana Department of Health			X	X	X	
Department of Insurance	X	X	X	X	X	
Department of Justice	X	X	X			
Louisiana Workforce Commission			X	X		
Department of Natural Resources			X			X
Louisiana Public Service Commission			X	X	X	
Louisiana Board of Regents	X	X	X			
Department of Revenue	X		X	X		
Department of Children & Family Services			X	X		
Louisiana Secretary of State	X	X	X			
Louisiana State Police			X			
University of Lafayette National Incident Management Systems and Advanced Technologies (NIMSAT)		X	X	X	X	
Louisiana Business Emergency Operation Center		X	X	X	X	
Department of Treasury	X	X	X			
Coastal Protection and Restoration Authority						X
Non-Governmental Organizations (NGO) *			X	X	X	
Office of Community Development	X	X	X	X	X	X
Louisiana Housing Corporation	X	X	X	X	X	
Louisiana Family Recovery Corps		X	X	X		

APPENDIX 2: ESF – 14 DISASTER RECOVERY FRAMEWORK STATE-FEDERAL CROSSWALK

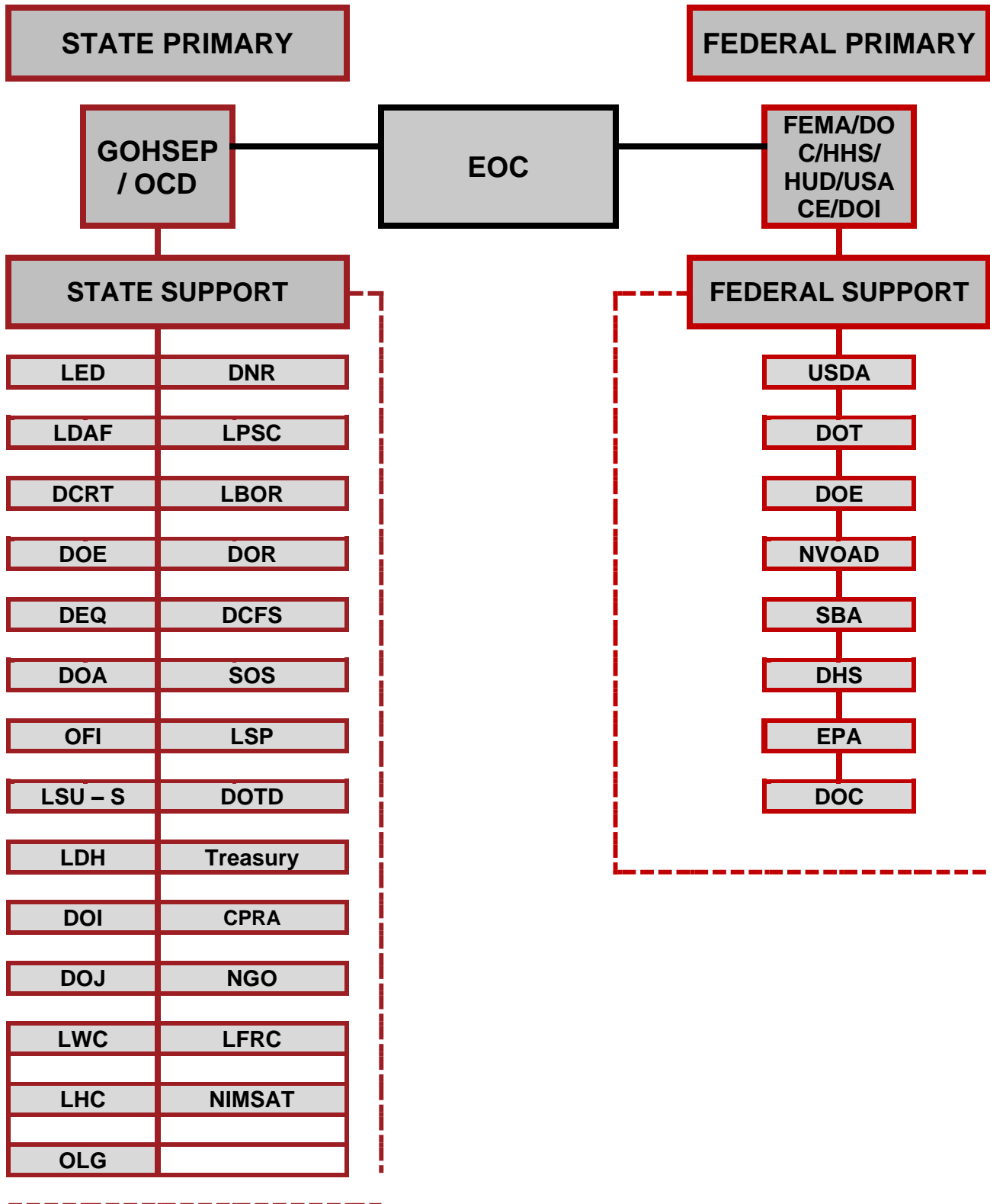

# **EMERGENCY SUPPORT FUNCTION 15 EMERGENCY PUBLIC INFORMATION ANNEX**

## **I. PURPOSE**

The purpose of this annex is to provide a plan for the effective collection, control and dissemination of Emergency Public Information (EPI) in efforts to protect life and property. The plan also calls for measures to be taken to ensure accurate reporting so that the public is not confused or misled in times of emergency.

## **II. SCOPE**

The scope of ESF 15 is to provide timely and accurate information to the media in order to inform the public about the threat of a natural disaster or the response to an emergency in effort to save lives. ESF 15 delivers public information about precautionary measures in advance of a disaster such as evacuation, sheltering and property protection. Encouraging disaster preparedness, keeping the public aware of hazardous situations and informing them of the progression of the disaster/emergency is key to protecting their lives and property. ESF 15 will continually provide situational updates to the public on measures the state is taking to protect and preserve life and property.

ESF 15 will disseminate clear, concise and accurate public information before, during and after disasters and emergencies. The information will be based on the factual situation in the disaster area, the actions taken by the authorities and the recommended steps to be taken by the people. Every effort will be made to correct inaccurate reporting in the media.

## **III. CONCEPT OF OPERATIONS**

### **A. MITIGATION:**

1. The GOHSEP Director, will designate an ESF 15 Coordinator who will be the coordinator of information programs and initiatives.
2. The ESF 15 Coordinator will coordinate with other state departments and agencies to develop and maintain information and education programs for the general public.

### **B. PREPAREDNESS:**

1. The GOHSEP Communications Director will disseminate preparedness information to the public prior to and throughout hurricane season. The Public Information Officer (PIO) will distribute information to the media through press releases, kits and press conferences. The information will also be available on the GOHSEP website. A wide variety of educational materials dealing with emergency management and disaster preparedness will be available in ready-to-distribute form or as fact sheets whose content may be incorporated into locally developed materials.
2. The GOHSEP PIO will produce television and radio PSAs on preparedness. The PSAs will instruct the public on making a disaster supply kit, creating a family communication plan, evacuating and other important information.
3. The ESF 15 Coordinator will develop plans, procedures and agreements with other state agencies, private and commercial communications including the media, volunteer associations and individuals in order to have responsive channels for the dissemination of emergency information.

4. The ESF 15 Coordinator will develop plans, procedures and agreements to provide emergency information to special populations including the visual and hearing-impaired.
5. The ESF 15 Coordinator will develop plans, procedures and agreements for the activation and operation of a Joint Information Center (JIC) for large scale and catastrophic incidents and emergencies. The ESF Coordinator will work with federal authorities to make sure that federal government public information activities will be integrated into the State JIC as needed.

#### C. RESPONSE:

1. The ESF 15 Coordinator will begin operating in the State EOC and initiate contact with the Public Information Officers of state and local agencies to ensure that valid and timely information is processed and released to the news media and the public. The highest priority will be for information about potential threats to the public. Evacuation warnings will be given special attention. An aggressive rumor control effort will be pursued.
2. The ESF 15 Coordinator or designee, will release all official Emergency Public Information, (EPI) provided by the GOHSEP Director about state operations and assistance during a disaster.
3. If the event is of such a magnitude that catastrophic news coverage can be expected, the ESF 15 Coordinator will advise the GOHSEP Director whether it would be advisable to activate a JIC. When the decision to activate is made, the ESF 15 Coordinator will ensure that all appropriate organizations and individuals are represented and able to function in the JIC. When federal authorities enter into operations they will be integrated into the JIC.
4. 4. ESF 15 will utilize social media platforms in addition to traditional news release methods to share critical information with the public before, during and after an All Hazards event. Those efforts will also be coordinated with other JIC representatives when the JIC is activated.

#### D. RECOVERY:

1. Emergency Public Information activities will continue as long as they are needed. The ESF 15 Coordinator will continue to monitor information needs to determine when activities can be turned to recovery.
2. As soon as possible after the emergency has passed, all agencies involved in the emergency will conduct assessments. Assessments will be used to define the need for resources and strategies needed for future operations. If a JIC had been activated its operations will be evaluated and, if necessary, its operational procedures will be reviewed and changed for future operations.
3. ESF 15 will utilize social media platforms in addition to traditional news release methods to share critical recovery information with the public during the recovery phase of an All Hazards event. Those efforts will also be coordinated with other JIC representatives when the JIC is activated.

### IV. ORGANIZATION AND RESPONSIBILITIES

- A. GOHSEP has primary responsibility for initiating, organizing and coordinating all aspects of Emergency Public Information.

B. The support agencies for ESF 15 are responsible for developing and maintaining plans, procedures and asset inventories to support the primary coordinator. Support agencies include, but are not limited to:

1. Louisiana National Guard
2. Senate and House Legislative Liaisons
3. Department of Agriculture and Forestry
4. Department of Corrections
5. Department of Culture, Recreation & Tourism
6. Department of Economic Development
7. Department of Education
8. Department of Environmental Quality
9. State Fire Marshal
10. Division of Administration
11. Office of Disability Affairs
12. Office of Elderly Affairs
13. Office of Financial Institutions
14. Office of Indian Affairs
15. Office of the Lieutenant Governor
16. Louisiana Oil Spill Coordinators Office
17. Louisiana State University System
18. Louisiana Department of Health
19. Department of Insurance
20. Department of Justice
21. Louisiana Workforce Commission
22. Department of Natural Resources
23. Louisiana Public Service Commission
24. Louisiana Board of Regents
25. Department of Revenue
26. Department of Children and Family Services
27. Louisiana Secretary of State
28. Louisiana State Police
29. Department of Transportation and Development
30. Department of the Treasury
31. Department of Wildlife and Fisheries
32. Louisiana Coastal Protection and Restoration Authority
33. Non-Governmental Organizations (NGO)

## **V. COMMAND AND CONTROL**

Command and Control will be exercised as provided in the Basic Plan.

## **VI. CONTINUITY OF GOVERNMENT**

Continuity of government will be as provided in the Basic Plan.

## **VII. ADMINISTRATION AND LOGISTICS**

- A. If local, parish and state resources are inadequate to the tasks assigned; the ESF 15 Coordinator will seek additional resources from EMAC and from the federal government pursuant to a Presidential Disaster Declaration.
- B. Every agency providing ESF 15 services will maintain records of the operations, including cost records that can be used after the emergency to obtain reimbursement from state or federal resources.

## **VIII. PLAN MAINTENANCE**

The ESF 15 Coordinator is responsible for developing, maintaining and coordinating plans, procedures, arrangements and agreements in support of this ESF.

## **IX. AUTHORITIES AND REFERENCES**

Authorities and references are included in the Basic Plan.

## **X. APPENDICES**

- A. ESF 15 Responsibility Chart
- B. State-Federal Crosswalk

**APPENDIX 1 – ESF 15  
EMERGENCY PUBLIC INFORMATION RESPONSIBILITY CHART**

<b>Agency support to the Governor’s Office of Homeland Security and Emergency Preparedness</b>	<b>Spokespersons</b>	<b>Coordination</b>	<b>Media Facilities</b>	<b>Printing and Dissemination</b>
Louisiana National Guard	X	X		
Senate and House Legislative Liaisons	X	X		
Department of Agriculture and Forestry	X	X		
Department of Corrections	X	X		
Department of Culture, Recreations & Tourism	X	X		
Department of Economic Development	X	X		
Department of Education	X	X	X	
Department of Environmental Quality	X	X		
State Fire Marshal	X	X		
Division of Administration	X	X		X
Office of Disability Affairs	X	X		
Office of Elderly Affairs	X	X		
Office of Financial Institutions	X	X		
Office of Indian Affairs	X	X		
Office of the Lieutenant Governor	X	X		
Louisiana Oil Spill Coordinators Office	X	X		
Louisiana State University System	X	X		
Louisiana Department of Health	X	X		
Department of Insurance	X	X		
Department of Justice	X	X		
Louisiana Workforce Commission	X	X		
Department of Natural Resources	X	X		
Louisiana Public Service Commission	X	X		
Louisiana Board of Regents	X	X	X	X
Department of Revenue	X	X		
Department of Children and Family Services	X	X		
Secretary of State	X	X		
Louisiana State Police	X	X	X	
Department of Transportation and Development	X	X		X
Department of the Treasury	X	X		
Department of Wildlife and Fisheries	X	X		
Louisiana Coastal Protection and Restoration	X	X		
Non-Governmental Organizations (NGO) *	X	X		



**APPENDIX 2 – ESF 15  
EMERGENCY PUBLIC INFORMATION STATE – FEDERAL CROSSWALK**

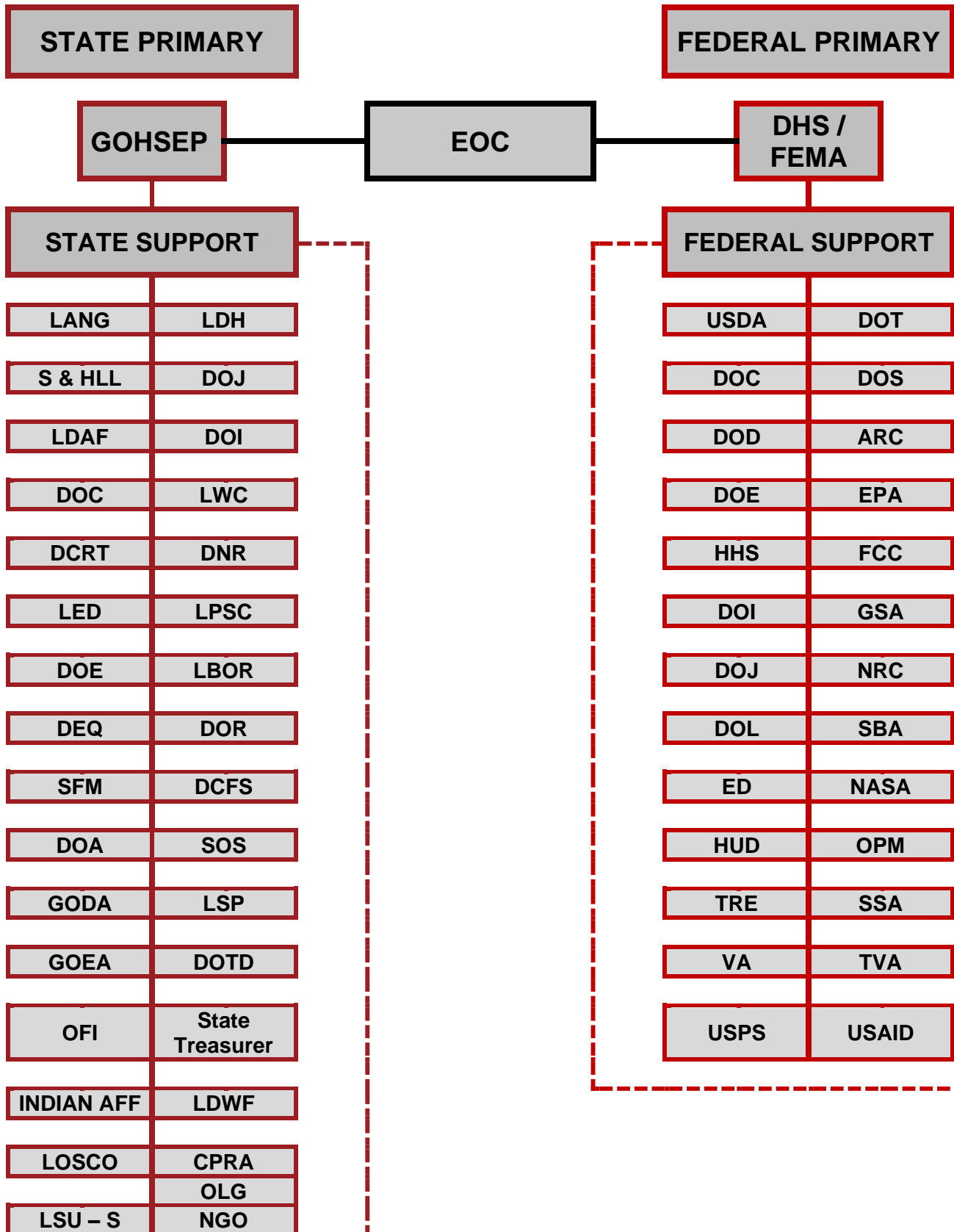

**EMERGENCY SUPPORT FUNCTION 16  
MILITARY SUPPORT TO CIVILIAN AUTHORITIES (MSCA) ANNEX**

**I. PURPOSE**

ESF 16 Defense Support to Civilian Authorities (DSCA) provides a framework for the mobilization, deployment and use of Louisiana National Guard military personnel, equipment and resources to respond to protect and preserve life and property during emergencies and disasters, when local and state civilian resources are exhausted and/or not sufficient to accomplish the needed actions. This includes the command, control and coordination of all other non-federal military support operating in the state, as well as coordination and situational awareness of all Department of Defense Support to Civilian Authorities (DSCA) assets operating in the state under a Federal Emergency Management Agency (FEMA) Mission Assignment.

**II. SCOPE**

The ESF will encompass the operations of the State Military Department and the Louisiana National Guard, and the National Guard assets available from other states through the Emergency Management Assistance Compact (EMAC). In addition, the ESF will coordinate with DSCA forces operating in the State of Louisiana under FEMA Mission Assignment, providing situational awareness and integration of federal active duty and reserve armed forces.

**III. CONCEPT OF OPERATIONS**

**A. MITIGATION:**

The Adjutant General for Louisiana will designate an ESF 16 Coordinator for Defense Support to Civilian Authorities (DSCA).

**B. PREPAREDNESS:**

1. The ESF 16 Coordinator will develop plans, procedures, agreements and arrangements with other state agencies, groups and individuals in order to have a comprehensive and flexible response capability.
2. The ESF 16 Coordinator will develop training and exercise plans to ensure that the military units and assets of the state will be prepared to deploy and support emergency operations, with a particular emphasis on large scale and catastrophic incidents and emergencies. The ESF Coordinator will work with other states and federal authorities to make sure that their assets can be integrated into the state operations as needed.

**C. RESPONSE**

1. The ESF 16 Coordinator will begin operating when requested by GOHSEP or at the direction of the governor when an emergency begins, and will relay alerting and warning information as required to the Military Department throughout the state.
2. The ESF 16 Coordinator will receive, validate, assign and track mission assignments to the Military Department so that assets are deployed as needed to support lead emergency support functions response activities for security; search & rescue; command, control & communications; situational awareness; and logistics activities for commodities distribution.

3. If the event is of such a magnitude that catastrophic effects can be expected, the ESF 16 Coordinator will advise GOHSEP on whether it would be advisable to request additional military assets via EMAC. The Military Department will work with the incoming assets to ensure that they are smoothly integrated into the overall response. In addition, if FEMA mission assignments task DSCA assets, ESF-16 coordinates and maintains situational awareness of DSCA assets operating in Louisiana.

#### D. RECOVERY:

1. Military Support activities will continue as long as they are required by the state or federal tasking authority. The coordinator will continue to monitor information in order to determine when activities can be turned over to recovery and reconstitute for future response operations.
2. As soon as possible after the emergency has passed, all units involved in the emergency will conduct assessments, which will be used to define the need for resources and strategies needed for future operations.

#### IV. ORGANIZATION AND RESPONSIBILITIES

The Louisiana Adjutant General and his designated coordinator has primary responsibility for initiating, organizing and coordinating all aspects of Military Support to Civilian Authorities.

#### V. COMMAND AND CONTROL

Command and Control will be exercised as provided in the Basic Plan.

#### VI. CONTINUITY OF GOVERNMENT

Continuity of government will be as provided in the Basic Plan.

#### VII. ADMINISTRATION AND LOGISTICS

1. If State resources are inadequate to the tasks assigned; the ESF 16 Coordinator will advise the Director, GOHSEP, to seek additional resources from EMAC and from the federal government pursuant to a Presidential Disaster Declaration.
2. All units providing ESF 16 services will maintain records of the operations, including cost records that can be used after the emergency to obtain reimbursement from state or federal resources.

#### VIII. PLAN MAINTENANCE

The ESF 16 Coordinator is responsible for developing, maintaining and coordinating plans, procedures, arrangements and agreements in support of this ESF.

#### IX. AUTHORITIES AND REFERENCES

Authorities and references are included in the Basic Plan.

#### X. APPENDICES

1. State – Federal Crosswalk

**APPENDIX 1 – ESF 16**  
**MILITARY SUPPORT TO CIVILIAN AUTHORITIES STATE-FEDERAL CROSSWALK**

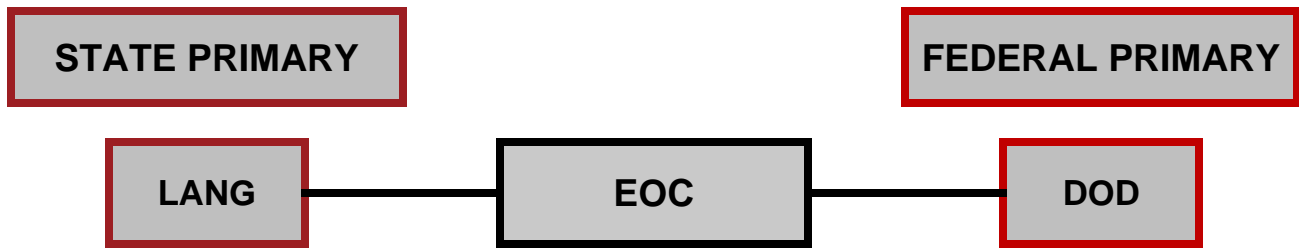

# **EMERGENCY SUPPORT FUNCTION 17 CYBER INCIDENT RESPONSE MANAGEMENT ANNEX**

## **I. PURPOSE**

ESF 17 provides a means of defining, specifying, and maintaining the functions and resources required to ensure timely and consistent actions, communications, and response efforts in the event of a significant cybersecurity incident. Additionally, ESF 17 ensures appropriate coordination and inclusion of necessary state, federal, local agencies and private industry in order to minimize the impact of a cybersecurity incident. Significant cybersecurity incidents may occur independently or in conjunction with disaster emergency operations and potentially impact public health and safety or critical infrastructure.

## **II. SCOPE**

State services under this ESF consist of the identification, mobilization and coordination of available state owned, private industry and volunteer personnel and equipment essential to respond, investigate, contain, recover, and otherwise manage 1) any significant cybersecurity incident impacting state entities, and 2) cyber disruptions of critical infrastructure; before, during and after an impending, suspected, or actual incident.

Cybersecurity incident response management is a critical component of the State's Information Security Program and required to properly protect operational technology, systems, and services. Cyber incident response readiness requires substantial planning and complex coordination of resources in order to establish a successful incident response capability. This ESF 17 and the State's supplemental Statewide Cyber Incident Response Plan (SCIRP) are developed using the principals provided within Presidential Policy Directive (PPD)-41: U.S. Cyber Incident Coordination and the National Cyber Incident Response Plan (NCIRP).

## **III. CONCEPT OF OPERATIONS**

The Division of Administration and the Louisiana National Guard will each designate an ESF 17 Cyber Incident Response Manager (CIRM) to coordinate with the necessary entities within the state to organize, collaborate, implement, and maintain an adequate level of cybersecurity incident response preparedness. Additionally, the designated CIRM will lead all active incident response phases to include reporting, recovery, and lessons learned.

The CIRM shall work with the affected entity, and when applicable, ensure proper inclusion of public relations, legal, human resources staff, or law enforcement resources prior to communication with any internal or external and public entities. The CIRM shall assign an initial incident severity level using the Cyber Incident Severity Classification Levels identified in the National Cyber Incident Response Plan (reference the Basic Plan pg. 31). It is critical to accurately assess and classify the potential impact of cybersecurity incidents while also utilizing a standard terminology to effectively address an incident.

The Governor's Office of Homeland Security will designate a Cyber Incident Response Coordinator to facilitate communication and reporting between CIRM(s) and State, Parish, and local partners. The Coordinator will also work with CIRM(s) to identify resource gaps and identify solutions. The Coordinator will work with Federal, State, and local partners to identify, and protect critical cyber infrastructure, as well as detect, respond, and recover from attacks on critical cyber infrastructure throughout the State.

The State of Louisiana defines a "State Cyber Incident" as: An incident that has been initiated by malicious cyber actors and has a direct impact or potential direct impact on the physical environment and/or results in a sustained economic disruption that includes a likely impact on the

public health and welfare (Classification Level 4 Cyber Incident) or imminent threat to loss of life (Classification Level 5 Cyber Incident).

#### A. PREVENTION:

1. Preventing cyber incidents is significantly less impactful and far more effective than reacting to them after they occur. Thus, cyber incident prevention is an important complement to a cyber incident response capability. Insufficient adoption of prevention requirements will increase the volume of cyber incidents, eventually overwhelming the resources, negatively affect the State's capacity for incident response, and result in more extensive damage.
2. State Agencies prevent cyber incidents by proper management and use of state networks, systems, and applications in compliance with the State's Information Security Policy.
3. Non-Governmental Organizations (NGO) and Private Industry reduce the opportunity or frequency of cyber incidents by creating, implementing, and maintaining policies and procedures to effectively secure networks, systems, and applications.

#### B. PROTECTION:

1. Similar to Prevention, State entities protect against cybersecurity risks by operating in compliance with the State's Information Security Policy.
2. Non-Governmental Organizations (NGO) and Private Industry prevent cyber incidents by adopting the National Institute of Standards and Technology (NIST) framework for improving Critical Infrastructure Cybersecurity.

#### C. MITIGATION:

1. Cyber incident response resources should report to the CIRM any potential improvements or capabilities necessary to reduce operational impact or loss property caused by a significant cyber incident or disruption.

#### D. PREPAREDNESS:

1. The CIRM will develop and maintain plans and procedures to ensure that all Cyber Incident Response Team (CIRT) members (or potential members) remain highly trained and exercised on a continual basis. An outreach program will be created and conducted to ensure that Louisiana entities, both public and private are aware of in state capabilities and response procedures.
2. The CIRM will maintain, in conjunction with their partners, the proper equipment and assets required to provide an expedient and efficient response to a cyber incident within Louisiana.
3. The CIRM will work with the appropriate support agencies and response partners to clearly establish, publish, and maintain any technical or technology related requirements vital to cyber incident response management within Louisiana.
4. The CIRM will establish relationships and maintain contact information for liaisons with public, private, and federal agencies and organizations to ensure smooth and successful communications in event of an incident.

5. The CIRM will work with agencies, partners, and private industry, to implement, manage, and monitor system events and audit logs in order to detect the occurrence of a cybersecurity event within both liaisons and impacted entities environments.

#### E. RESPONSE:

1. During any phase of cyber incident response, infrastructure owners, system operators, or response team resources may suspect or discover criminal activity. Immediately upon becoming aware of actual or suspected criminal activity the incident response team member will cease current task and notify the CIRM. The CIRM will then facilitate the appropriate escalation and inclusion of Law enforcement or threat response resources. Law enforcement threat response activities during a cyber-incident include investigative, forensic, analytical, and mitigation activities: interdiction of a threat actor; and providing attribution that may lead to information sharing and operational synchronization with asset response activities. Law enforcement threat response activities also include conducting appropriate law enforcement and national security investigative activities at the affected entity's site, linking related incidents and identifying additional affected or potentially affected entities.
2. The CIRM will work with and inform private industry entities performing critical roles in supporting threat response activities. Private industry entities provide immense value by reporting and sharing information regarding cyber incidents and malicious cyber activity in a timely manner to appropriate law enforcement agencies or government entities. Information, communications, and technology providers and manufacturers—such as Internet service providers, common carriers, manufacturers of key networking hardware, and major software companies—also play an important role in the threat response to malicious cyber activity, due to the potential exploitation or use of their systems by cyber threat actors. The *Cybersecurity Information Sharing Act of 2015* establishes legal protections and important conditions for sharing information with State and Federal Government.
3. The State of Louisiana will determine its response actions and the resources it brings to bear based on an assessment of the risks posed to an entity, state security, the broader economy, public confidence, privacy and civil liberties, or the public health and safety of the citizens of Louisiana. Critical infrastructure entities also conduct risk-based response calculations during cyber incidents to ensure the most effective and efficient utilization of resources and capabilities. Threat response activities encompass many resources and capabilities from across the law enforcement and defense community. Threat response activities during a cyber-incident include investigative, forensic, analytical, and mitigation activities; interdiction of a threat actor; and providing attribution that may lead to information sharing and operational synchronization with asset response activities. Threat response activities also include conducting appropriate law enforcement and national security investigative activities at the affected entity's site, linking related incidents, and identifying additional affected or potentially affected or vulnerable entities.
4. State level response resources will not disclose or share any details of the incident, as well as ensure strict adherence to any preexisting privacy, civil liberties, or confidentiality of information. Additionally, all incident response personnel and partners shall protect personally identifiable information (PII) in accordance with the Privacy Act of 1974 and will protect Protected Critical Infrastructure Information (PCII) in accordance with the Critical Infrastructure Act of 2002. Authorization for disclosure and handling of classified, controlled unclassified information, PII, PCII and data shared with mission partners will be determined in accordance with U.S. law, State Law and DOD policies and guidance (executive Order 12333, National Security Directive 42, National Disclosure Policy No. 1, DoDD 5230.11, DoDI 5230.11, DoDI 5200.01, DoDM 5200.01 V3, DoDM 5200.01 V4, and 6 CFR Part 29, Procedures for Handling Critical Infrastructure Information).

## F. RECOVERY:

1. State response activities will be conducted in a manner to facilitate restoration and recovery of an entity that has experienced or impacted by a cyber-incident, balancing investigative and security requirements, public health and safety, and the need to return to normal operations as quickly as possible.
2. The CIRM will coordinate an after-action review and produce a formal report upon completion of an incident or exercise with recommendations for opportunities to improve and/or mitigate future incident management.

## IV. ORGANIZATION AND RESPONSIBILITIES

- A. Division of Administration (DOA) Office of Technology Services (OTS) and The Louisiana National Guard (LANG) have primary responsibility for initiating, organizing, coordinating, and managing all aspects of cyber incident response capabilities.
- B. In the event of an active or suspected cybersecurity incident, any impacted or potentially impacted State Agency shall coordinate with the CIRM (or assigned delegate) to make available the necessary resources and personnel required to assist in the analysis, response, and recovery efforts.
- C. The Support Agencies for ESF 17 are responsible for implementing, maintaining, and executing plans, procedures, and assets applicable to provide the support required by the CIRM. Support agencies include, but are not limited to:
  1. Governor's Office of Homeland Security and Emergency Preparedness
  2. Louisiana State Police – LA SAFE
  3. Department of Justice
  4. Louisiana Board of Regents
  5. LSU's – Stephenson Disaster Management Institute
  6. Louisiana Optical Network Initiative (LONI Network)
  7. Louisiana Cyber Innovation Center
  8. Office of the Attorney General
  9. Office of the Governor
  10. Office of the Lt. Governor
  11. Secretary of State
  12. Department of Treasury
  13. Louisiana Commissioner of Insurance
  14. Louisiana Department of Health
  15. Department of Agriculture and Forestry
  16. Louisiana Public Service Commission
  17. Louisiana Workforce Commission
  18. Department of Education
  19. Department of Children and Family Services
  20. Department of Wildlife and Fisheries
  21. Department of Natural Resources
  22. Department of Environmental Quality
- D. Non-Governmental Organizations and Private Industry may have a voluntary role in cyber incident response with the State of Louisiana.

## V. COMMAND AND CONTROL

Command and control will be exercised as provided in the basic plan.



## **VI. CONTINUITY OF GOVERNMENT**

Continuity of government will be as provided in the basic plan.

## **VII. ADMINISTRATION, INTEROPERABILITY AND LOGISTICS**

The ESF 17 coordinators with DOA/OTS and LANG will initiate and maintain predefined standard event, incident, and escalation interoperability plans between responder tiers on the Interoperable Statewide Network.

## **VIII. PLAN MAINTENANCE**

The ESF 17 coordinators are responsible for developing, maintaining, coordinating, and communicating plans, procedures, arrangements, and agreements in support of this ESF.

## **IX. AUTHORITIES AND REFERENCES**

Authorities and references are included in the Basic Plan.

## **X. APPENDICES**

1. Cyber Incident Response Management Responsibility Matrix
2. Cyber Incident Response Management State – Federal Support Crosswalk
3. Cyber Incident Response Management support to a Parish/Political Subdivision/Tribal Flow Chart
4. ESF 17 Cyber Incident Response Management support to a Private Sector Entity Flow Chart

**APPENDIX 1 – ESF 17  
CYBER INCIDENT RESPONSE MANAGEMENT RESPONSIBILITY CHART**

Agency Support to Division of Administration and Louisiana National Guard	Policy Contribution\Enforcement\Awareness	Resource Coordination (as needed)	UCG Communications\Updates	Preparedness Training, Testing, & Procedures	Breach Notification (When Required)	Investigation or Evidence Collection (Upon CIRM Request)	Forensic Analysis (Upon CIRM Request)	Work Area and Prior Access Physical Access for CIRT	Provide CIRT (Upon CIRM Request)	Maintain Equipment and Supplies	Coordination with Law Enforcement Entities	Audit Monitoring and Alerting Capabilities	Participate in After Action Review
Governor’s Office of Homeland Security and Emergency Preparedness (GOHSEP)	X	X	X					X					X
Louisiana State Police (LA-SAFE)						X	X	X			X		X
Department of Justice (DOJ)	X	X				X							X
Board of Regents (BOR)	X	X											X
Louisiana Optical Network Initiative (LONI)				X				X	X	X		X	X
LSU–Stephenson Disaster Management Institute (SDMI)				X					X	X		X	X
Louisiana Cyber Innovation Center (CIC)				X				X	X			X	X
Impacted State Agency					X				X				X
Supporting State Agencies	X	X										X	
Non-Governmental Organizations (NGO) *							X		X				
<p>* When deemed necessary by the Cybersecurity Incident Response Manager (CIRM), organizations or individuals within private industry may be required to assist with critical ESF tasks, analysis, or provide qualified personnel for unfamiliar technology platforms.</p> <p><i>Potential organizations or individuals within private industry may include: professional associations, subject matter experts, individuals certified by technology manufactures, software \ hardware vendor support, etc.</i></p>													

**APPENDIX 2  
CYBER INCIDENT RESPONSE MANAGEMENT STATE – FEDERAL CROSSWALK**

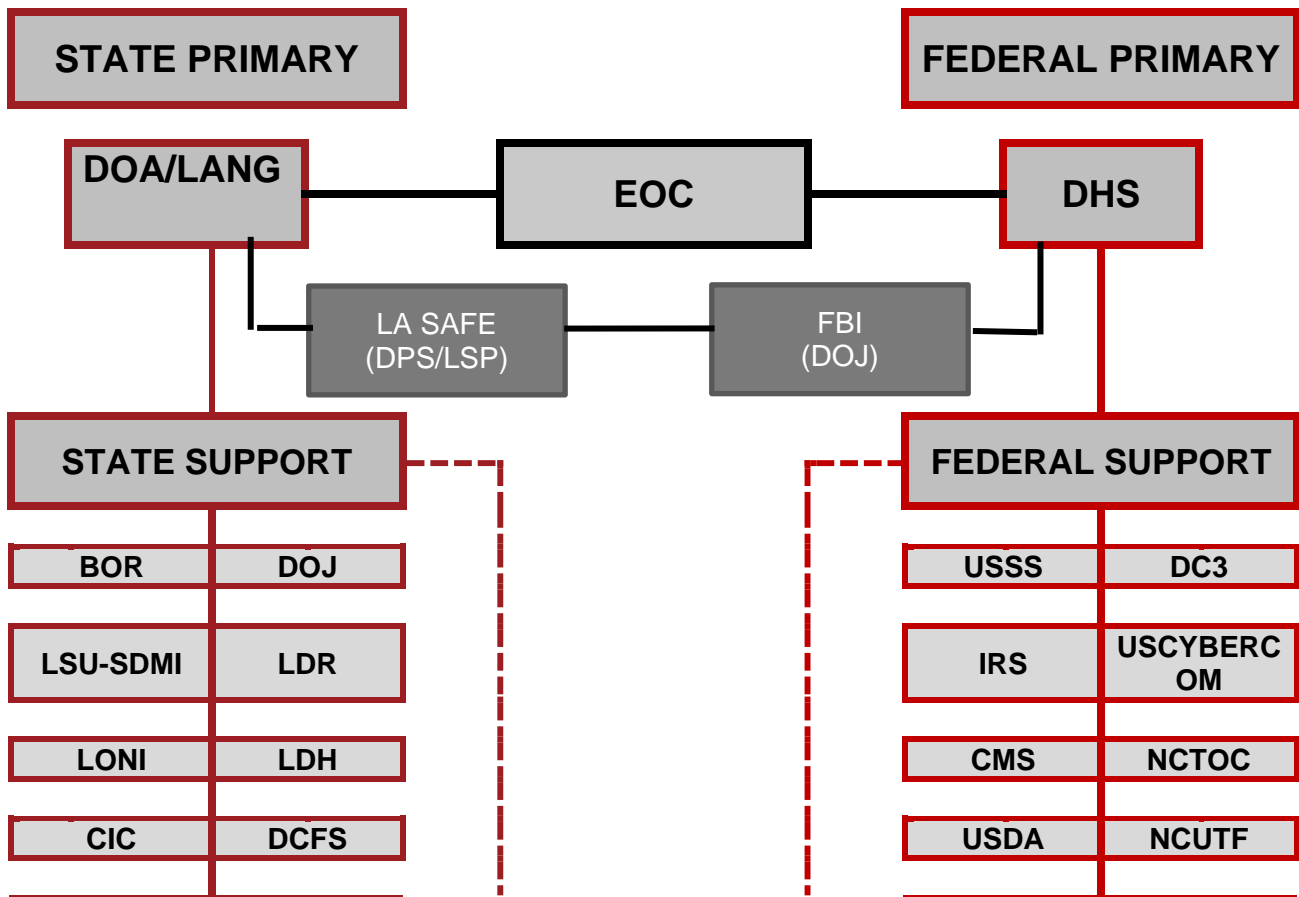

### APPENDIX 3

## CYBER INCIDENT RESPONSE MANAGEMENT SUPPORT TO A PARISH/POLITICAL SUBDIVISION/TRIBAL

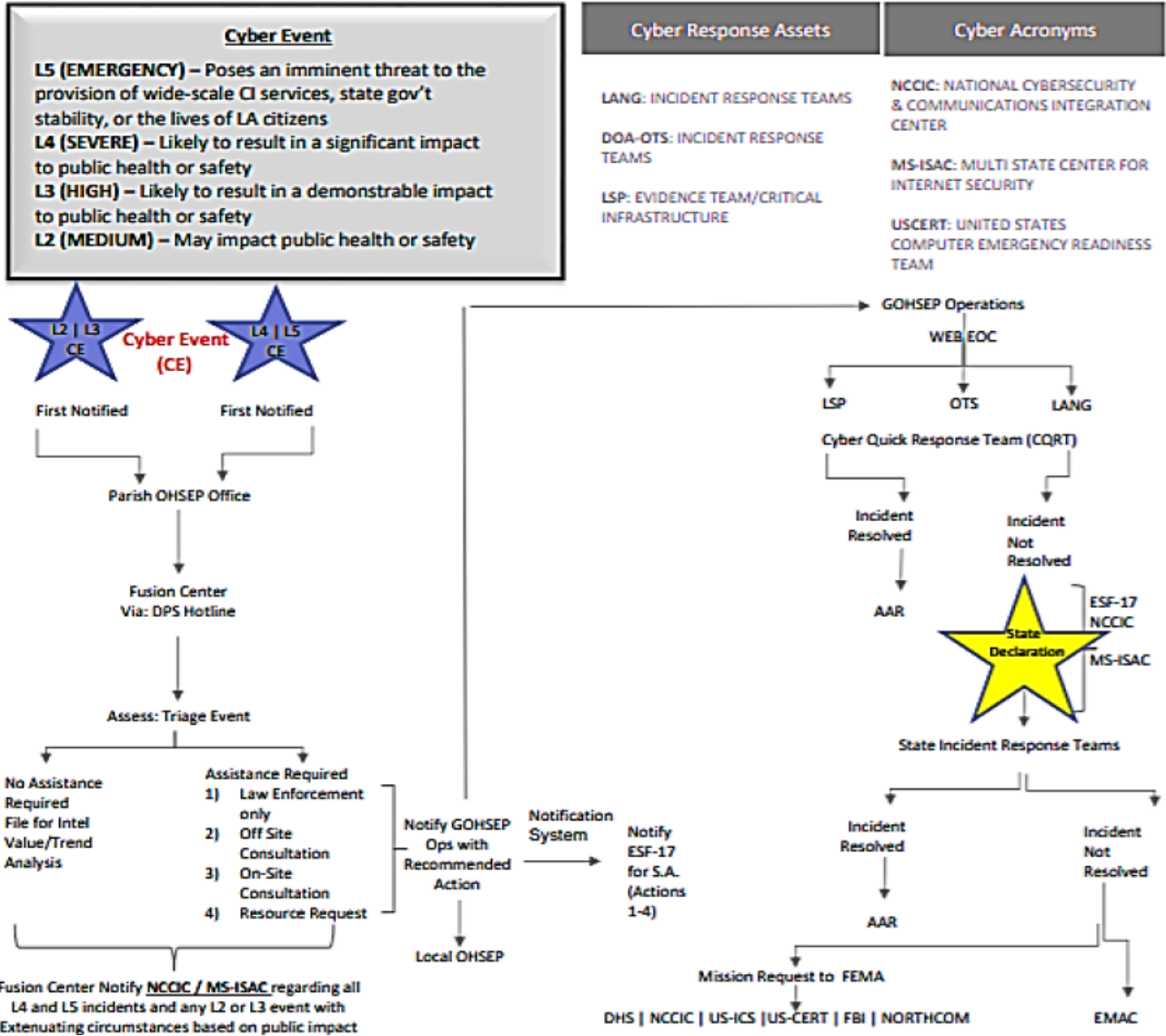

# ATTACHMENT 4

## CYBER INCIDENT RESPONSE MANAGEMENT SUPPORT TO A PRIVATE SECTOR ENTITY

